

HYDROMETEOROLOGICAL REPORT NO. 54

**Probable Maximum Precipitation and
Snowmelt Criteria for Southeast Alaska**

W/OHS
DIRECTOR
HYDROLOGIC RESEARCH LABORATORY

530 GRAMAY

HMP54:1

**U.S. DEPARTMENT OF COMMERCE
NATIONAL OCEANIC AND ATMOSPHERIC ADMINISTRATION
U.S. DEPARTMENT OF ARMY
CORPS OF ENGINEERS**

Silver Spring, Md
September 1983

U.S. DEPARTMENT OF COMMERCE
NATIONAL OCEANIC AND ATMOSPHERIC ADMINISTRATION

U.S. DEPARTMENT OF ARMY
CORPS OF ENGINEERS

HYDROMETEOROLOGICAL REPORT NO. 54

**Probable Maximum Precipitation and
Snowmelt Criteria for Southeast Alaska**

Prepared by
Francis K. Schwartz and John F. Miller
Hydrometeorological Branch
Office of Hydrology
National Weather Service

Silver Spring, Md.
September 1983

TABLE OF CONTENTS

	Page
ABSTRACT.....	1
1. Introduction.....	1
1.1 Background.....	1
1.2 Assignment.....	1
1.3 Approach to probable maximum precipitation.....	3
1.4 Format of report.....	3
2. Development of generalized mean annual precipitation map.....	3
2.1 Introduction.....	3
2.1.1 The problem.....	3
2.1.2 Previous studies.....	4
2.1.3 Degree of detail.....	4
2.2 Data.....	5
2.2.1 Precipitation data.....	5
2.2.2 Streamflow data.....	5
2.2.3 Snow course data.....	5
2.2.4 Upper air temperature data.....	14
2.3 First approximation to mean annual precipitation.....	14
2.3.1 Guidelines for first approximation.....	14
2.3.2 Analysis.....	15
2.4 Adjustment to mean annual precipitation chart based on analysis of data from small snow fields or glaciers.....	18
2.4.1 Accumulation season versus elevation.....	19
2.4.1.1 Temperature data.....	19
2.4.1.2 Precipitation data.....	19
2.4.1.3 Accumulation season percentages versus elevation.....	20
2.4.2 Development of melt curve for small glaciated areas.....	22
2.4.2.1 Purpose.....	22
2.4.2.2 Definition of useable glaciated areas.....	23
2.4.2.3 Data used in development of melt curve.....	24
2.4.2.4 Analysis with empirical fixes from "balanced" data- supported areas.....	24
2.4.2.5 Theoretical low-elevation melt-curve fix.....	28
2.4.2.6 Alternate determination of shape and magnitude of melt curve from temperature streamflow and snow course data.....	28
2.4.2.6.1 Spacing of April, May, and June melt curves.....	30
2.4.2.6.2 Spacing of melt curves for July, August, and subsequent months.....	34
2.4.2.6.3 Suggested shape and magnitude of melt curve from composite of empirical data.....	34
2.4.2.7 Snow course data as a check.....	34
2.4.2.8 Adopted melt curve.....	35
2.4.3 Use of melt curve for adjustment to first approximation on mean annual precipitation chart.....	35
2.5 Final mean annual precipitation chart.....	38

	Page	
3.	Probable maximum precipitation for southeast Alaska.....	38
3.1	Introduction.....	38
3.2	Relation between probable maximum precipitation and mean annual precipitation.....	39
3.2.1	Relation from western Washington.....	39
3.2.2	Adjustment of western Washington relation for use in southeast Alaska.....	39
3.3	Recurrence interval rainfall values versus probable maximum precipitation relations.....	41
3.3.1	Data and unadjusted relations.....	41
3.3.2	Adjustment of relation for estimating probable maximum precipitation.....	42
3.4	Combination of the methods for first approximation probable maximum precipitation.....	44
3.4.1	Additional support for combined relation.....	47
3.4.1.1	Use of largest probable maximum precipitation amounts from the contiguous United States.....	47
3.4.1.2	Non-orographic probable maximum precipitation based on northwest United States mean annual precipitation.....	48
3.5	First approximation of probable maximum precipitation and modification.....	53
3.5.1	First approximation of probable maximum precipitation.....	53
3.5.2	Modification of first approximation probable maximum precipitation.....	53
3.5.2.1	Relation between maximum observed 24-hr precipitation and mean annual precipitation.....	54
3.5.2.1.1	Anomaly analysis.....	54
3.5.2.2	Clues from storm situations.....	54
3.5.2.2.1	August 3-7, 1920.....	54
3.5.2.2.2	September 25-28, 1918.....	54
3.5.2.2.3	December 4-7, 1964.....	60
3.5.2.2.4	July 6-11, 1969.....	60
3.5.2.2.5	Summary.....	60
3.5.2.3	Establishment of the probable maximum precipitation general level for sheltered regions.....	64
3.5.2.4	Examples of modifications to first-approximation probable maximum precipitation.....	65
3.5.3	Adjusted 24-hr 10-mi ² Probable Maximum Precipitation Chart	66
3.6	Summary remarks.....	66
3.7	Seasonal variation of probable maximum precipitation for basins in southeast Alaska.....	66
3.7.1	Data and analysis.....	66
3.7.2	Conclusion.....	68
3.8	Depth-area-duration relations for southeast Alaska probable maximum precipitation.....	69
3.8.1	Depth-area-duration to 24 hours.....	69
3.8.2	Extension of relations to 72 hours.....	70
3.8.2.1	Adopted 3- to 1-day ratio for 10-mi ² (26-km ²) rainfall....	70
3.8.2.2	Extension of depth-duration ratios to other area sizes....	71
3.8.3	Procedure for use of basic depth-area-duration values.....	71
3.8.4	Areal distribution of probable maximum precipitation.....	72

	Page	
4.	Generalized snowmelt criteria.....	73
4.1	Introduction.....	73
4.2	Temperature criteria.....	74
4.2.1	Temperature criteria during the 3-day probable maximum precipitation.....	74
4.2.2	Temperature criteria prior to 3-day probable maximum precipitation.....	74
4.2.2.1	Mean temperature charts.....	75
4.2.2.2	High-temperature case departures.....	75
4.2.2.3	High-dew-point case departures.....	77
4.2.2.4	Elevation variations.....	79
4.2.3	Upper limit of mean daily temperature over snow cover.....	79
4.2.4	Half-day temperature criteria.....	79
4.2.5	Schematic of temperature criteria.....	80
4.3	Dew-point criteria.....	80
4.3.1	Dew-point criteria during the 3-day probable maximum precipitation.....	80
4.3.2	Dew-point criteria for high-temperature sequence prior to 3-day probable maximum precipitation.....	82
4.3.3	Dew-point criteria for high-dew-point sequences prior to 3-day probable maximum precipitation.....	82
4.3.4	Elevation variation of dew points.....	82
4.3.5	Upper limit.....	82
4.3.6	Half-day dew-point criteria.....	82
4.3.7	Schematic of snowmelt dew-point criteria.....	84
4.4	Wind criteria.....	84
4.4.1	Wind criteria during the 3-day probable maximum precipitation.....	84
4.4.1.1	Seasonal variation factors.....	84
4.4.1.2	Barrier adjustments.....	84
4.4.1.3	Elevation variation of wind during probable maximum precipitation.....	85
4.4.2	Winds prior to probable maximum precipitation.....	87
4.4.2.1	Winds prior to probable maximum precipitation - high- dew-point case.....	87
4.4.2.2	Winds prior to probable maximum precipitation - high- temperature case.....	88
4.4.2.3	Elevation variation/of winds in high-temperature case.....	88
4.5	Support for adopted wind and temperature criteria.....	88
4.6	Stepwise procedure for snowmelt criteria (other than snowpack).....	90
4.6.1	Steps for obtaining temperatures prior to probable maximum precipitation.....	90
4.6.2	Steps for obtaining dew points prior to probable maximum precipitation.....	90
4.6.3	Steps for obtaining daily dew points and daily temperatures during probable maximum precipitation.....	91
4.6.4	Steps for obtaining half-day dew-point and temperature values.....	91
4.6.5	Steps for obtaining winds during probable maximum precipitation.....	92

	Page	
4.6.6	Steps for obtaining winds prior to the 3-day probable maximum precipitation - high-temperature case.....	92
4.6.7	Steps for obtaining winds prior to the 3-day probable maximum precipitation - high-dew-point case.....	93
4.7	Snowpack criteria.....	93
4.7.1	Introduction.....	93
4.7.1.1	Working hypotheses.....	93
4.7.2	Background data.....	94
4.7.2.1	Snow-course data.....	94
4.7.2.2	Station data.....	95
4.7.2.3	Snowmelt computations.....	95
4.7.2.4	Previous snowpack estimates.....	95
4.7.3	Procedure for snowpack determination.....	95
4.7.3.1	First approximation to snowpack.....	96
4.7.3.2	Adjustment to length of snow accumulation season.....	96
4.7.3.3	Melt between end of snow accumulation season and probable maximum precipitation.....	96
4.7.3.4	Geographic variation.....	98
4.7.4	Stepwise procedure for snowpack (water equivalent) determination.....	99
4.7.5	Trial computations and comparisons.....	101
4.8	Example of use of snowmelt criteria.....	104
4.8.1	Snowpack determination.....	105
4.8.2	Temperature criteria prior to probable maximum precipitation.....	107
4.8.3	Dew-point criteria prior to probable maximum precipitation.....	107
4.8.4	Temperature and dew-point criteria during the probable maximum precipitation.....	108
4.8.5	Half-day values of temperature and dew points.....	108
4.8.6	Wind criteria.....	109
4.8.6.1	Winds during probable maximum precipitation.....	109
4.8.6.2	Winds prior to probable maximum precipitation.....	110
	Acknowledgments	111
	References.....	112
	Appendix.....	115

LIST OF FIGURES

Number		Page
1.	Alaska showing the study region.....	2
2.	Area-elevation curve.....	4
3.	Location of precipitation stations and stream gages.....	8
4.	Mean Annual Precipitation Chart for southeast Alaska.....	13
5.	Outline of basins whose data were used to aid in development of Mean Annual Precipitation chart.....	16
6.	Generalized elevation contours for southeast Alaska.....	17
7.	Analysis of upper air temperature based upon Juneau (after Ratner).....	20
8.	Variation of snowpack water equivalent with elevation and mean annual precipitation.....	23
9.	Examples of parallelograms for balanced areas.....	25
10.	Analysis of mean annual precipitation (inches) with adjoining basin runoff as input.....	26
11.	Melt curve from balanced areas.....	27
12.	Alternate estimate of melt curve with supporting data.....	29
13.	Melt curve vs. mean annual precipitation and elevation for adjustments to first approximation mean annual precipitation chart.....	36
14.	Location of western Washington points used for probable maximum precipitation vs. mean annual precipitation relation.....	40
15.	Probable maximum precipitation vs. mean annual precipitation from western Washington data.....	41
16.	Variation of frequency of lows with latitude offshore of west coast of North America.....	42
17.	100-yr, 24-hr precipitation vs. mean annual precipitation for southeast Alaska data.....	43
18.	Adjusted linear relations from figures 15 and 17, adopted linear relations and comparisons.....	45
19.	Area in Washington used for determining average orographic effects.....	50

	Page
20. Area in British Columbia used for determining average orographic effects.....	52
21. Maximum observed 24-hr precipitation vs. mean annual precipitation for southeast Alaska.....	57
22. Surface weather maps for August 3-7, 1920.....	58
23. Surface weather maps for September 25-28, 1918.....	59
24. Surface weather maps for December 4-7, 1964.....	61
25. Upper air (500-mb) weather maps for December 4-7, 1964.....	62
26. Surface weather maps for July 6-11, 1969.....	63
27. 24-hr, 10-mi ² PMP (in.) for southeast Alaska.....	67
28. Histogram of month of occurrence of maximum daily precipitation.....	68
29. Seasonal variation of probable maximum precipitation for southeast Alaska.....	69
30. Depth-area-duration relation for southeast Alaska probable maximum precipitation.....	72
31. Mean sea-level temperature (°F) for study area mid-March to mid-June.....	76
32. Temperature departures in relation to peak daily temperatures.....	77
33. Schematic for snowmelt temperature criteria.....	78
34. 24-hr sea-level dew-point (°F) for study area mid-March to mid-June.....	81
35. Schematic for snowmelt dew-point criteria.....	83
36. Schematic for snowmelt wind criteria.....	86
37. Relation of wind to temperature for differing marine areas.....	89
38. Schematic for illustrating how mean annual precipitation variation can be determined for use in snowpack accumulations when mean annual precipitation >150 in. (3810 mm).....	97
39. Snowpack related to month and elevation as percent of mean annual precipitation.....	98

	Page
40. Required melt for period of time up to probable maximum precipitation.....	99
41. Geographic variation of first approximation snowpack estimates (in percent).....	101
42. Schematic of procedure to determine snowpack water equivalent for use with probable maximum precipitation.....	102
43. Comparison of computed and observed snowpack values for various locations in southeast Alaska.....	103

LIST OF TABLES

1. Mean annual precipitation data for southeast Alaska.....	6
2. Streamflow data used in development of the mean annual precipitation chart.....	9
3. Locations of snow courses used in this study.....	14
4. Mean upper air temperatures for Juneau	14
5. Snowpack accumulation season.....	20
6. Monthly contribution to mean annual precipitation.....	21
7. Accumulation season snowpack water equivalent in percent of mean annual precipitation	22
8. Mean estimated monthly snowmelt runoff in inches by basins for five seasons 1960-61 through 1964-65.....	31
9. June runoff for the Baranof River.....	32
10. June snowmelt estimates for various partially glaciated basins	32
11. Estimated snowmelt runoff for Mendenhall River drainage.....	33
12. Stations used to develop recurrence interval versus probable maximum precipitation relations.....	44
13. Mean annual precipitation for coastal and near coastal stations in southeast Alaska.....	51
14. Mean orographic increases.....	51
15. Station precipitation data for southeast Alaska.....	55

	Page
16. Seasonal variation in percent of October 1 probable maximum precipitation.....	68
17. Depth-area-duration relations to 24 hr and 400 mi ² (1,036 km) in percent of the 24-hr 10-mi ² (26 km ²) probable maximum precipitation.....	70
18. Summation of temperature departures (°F) for unusual warm spells	77
19. Elevation adjustments for wind during and period prior to probable maximum precipitation for high-dew-point case.....	85
20. Elevation adjustments for wind for high-temperature case prior to probable maximum precipitation.....	88
21. Maximum observed and mean snowpack water-equivalent values for selected snowcourses in southeast Alaska.....	94
22. Preliminary snowpack computations for 500-ft (152 m) elevation increments for Takatz Creek basin.....	106
23. Final snowpack values for 500-ft (152 m) elevation increments for Takatz Creek basin.....	107

PROBABLE MAXIMUM PRECIPITATION AND SNOWMELT CRITERIA FOR SOUTHEAST ALASKA

Francis K. Schwarz and John F. Miller
Water Management Information Division
Office of Hydrology, National Weather Service
National Oceanic and Atmospheric Administration
U. S. Department of Commerce

ABSTRACT. This study gives probable maximum precipitation (PMP) estimates for durations between 6 and 72 hours for area sizes between 10 and 400 mi² (26 and 1036 km²) for any location in Southeast Alaska (except for the extreme northwest section). In addition to all-season PMP, estimates are provided for the spring and early summer snowmelt season.

This study also provides generalized estimates of snowpack and other snowmelt criteria including temperatures, dew points, and winds. A stepwise procedure is included showing how the information developed may be used.

1. INTRODUCTION

1.1 Background

Over a considerable span of time, numerous estimates of probable maximum precipitation (PMP) for Alaska have been made for individual basins. These studies involved a variety of approaches, particularly in regard to handling the orographic problem in a region greatly deficient in data. Some of the specific unpublished basin estimates since 1960 include the Bradley Lake Basin (54 mi², 140 km²) in 1961, the Chena River Basin (2,070 mi², 5,361 km²) in 1962, the Long Lake Basin (30.2 mi², 78 km²) in 1965, the Takatz Creek Basin (10.6 mi², 27 km²) in 1967, four small basins near Ketchikan in 1974, and four larger basins of the Susitna River Drainage ranging in size from 1,260 mi² (3,263 km²) to 5,840 mi² (15,126 km²) in 1975.

In 1966, a more comprehensive study including generalized snowmelt criteria was done for the Yukon River Basin above Rampart Dam site (200,000 mi², 518,000 km²) (U.S. Weather Bureau 1966). A generalized PMP report for all of Alaska provided all season estimates for areas up to 400 mi² (1,036 km²) and durations to 24 hours (Miller 1963). Since that report provided estimates for the entire State, it did not provide detailed results for any particular region. The present report concentrates on a small portion of the State, the southeastern portion only, and presents more detailed estimates of PMP. The study area is the portion of southeast Alaska that is south of a line that extends northeastward from the coast at 58°45'N to the Canadian border (fig. 1).

1.2 Assignment

The authorization for generalized meteorological criteria was given in a memorandum from the Corps of Engineers (COE) dated February 10, 1976. First priority was given to the development of generalized all-season PMP values. Next a study was to be conducted giving spring and early summer PMP estimates and necessary criteria for developing the snowmelt flood.

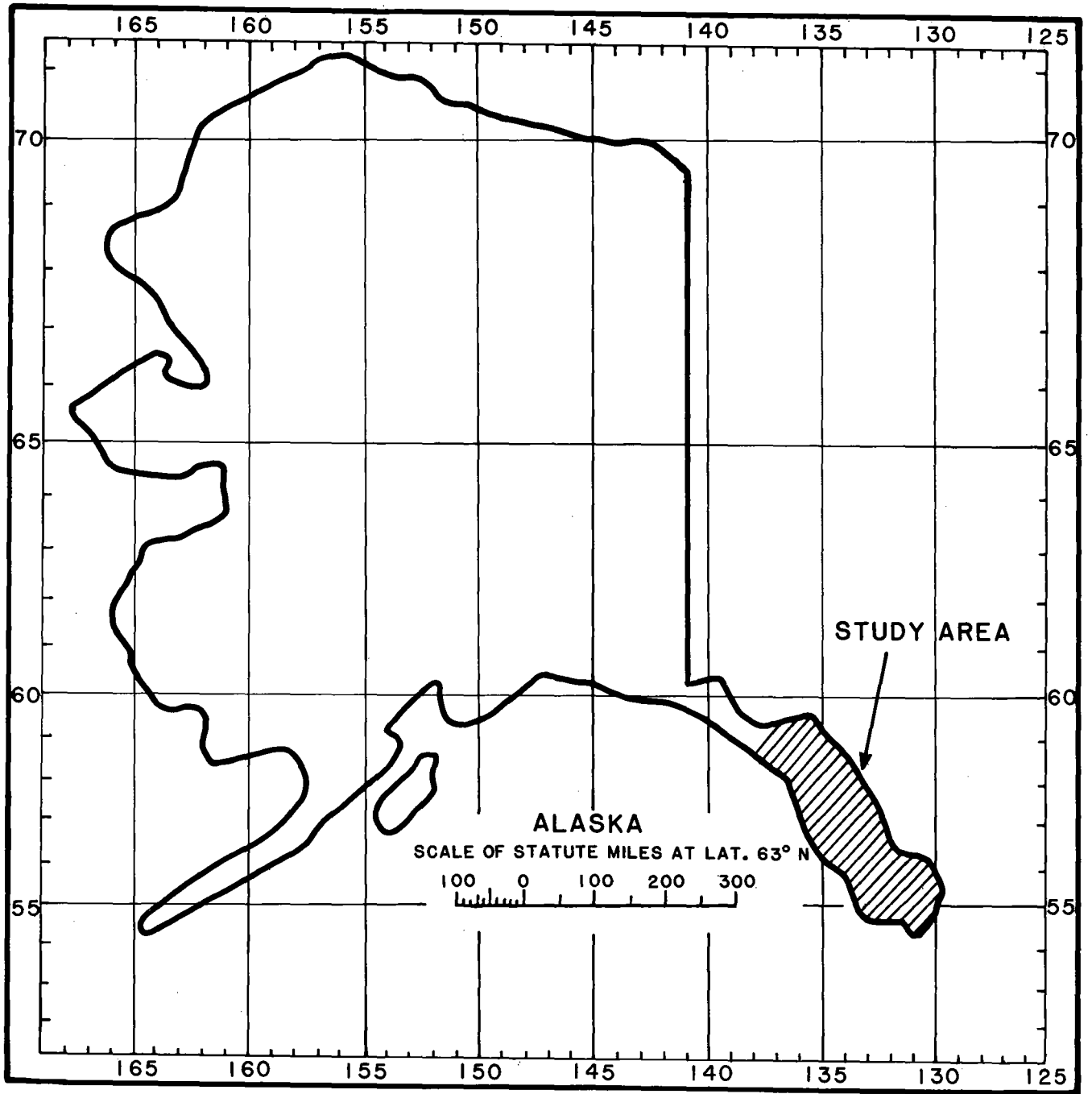

Figure 1.--Alaska showing the study area.

1.3 Approach to Probable Maximum Precipitation

In developing an approach to preparing generalized PMP estimates for a region like southeast Alaska, two factors must be considered. One is the complicated topography of the region. The second is the sparsity of daily or hourly precipitation measurements. Most of these measurements have been made within the first few hundred feet near the coastlines of the various islands or along the numerous bays and estuaries. Data are nearly nonexistent for the remaining 70 percent of the basin which is above 500 ft (152 m) (fig. 2). These conditions required developing and adopting relations from other regions and using other indices of precipitation magnitude.

Annual streamflow data were combined with available precipitation data to develop a mean annual precipitation (MAP) chart. This along with analysis of small glaciers and snowpack-accumulation season was used as guidance to delineation of generalized PMP estimates. Relations of MAP to PMP in the Northwest States (U.S. Weather Bureau 1966) were developed and adjusted to the PMP magnitude determined as appropriate for the study. A second approach was based on relations between storm precipitation and PMP in the Northwest States region. A first approximation of generalized PMP was developed first from these two relations and then adjusted by a variety of techniques to provide the basic 24-hr, 10-mi² (26-km²) PMP map. Depth-duration relations were generalized to provide estimates for durations to 72 hours and areas to 400 mi² (1,036 km²). Seasonal variation factors (to cover the spring snowmelt season) were also developed for the period from May 15 to October 1.

1.4 Format of Report

Chapter 2 is devoted to the development of the MAP. A portion of this development involved a relation between MAP and the variation of the snow accumulation season with elevation.

The development of 24-hr, 10-mi² PMP (26-km²) is covered in chapter 3. It includes the generalized depth-area-duration relation of PMP. The seasonal variation of PMP to cover the snowmelt season is also discussed.

Chapter 4 covers generalized criteria for the snowmelt flood. Included are maximum snowpack, and sequences of critical snowmelting temperature, dew points, and winds.

2. DEVELOPMENT OF GENERALIZED MEAN ANNUAL PRECIPITATION MAP

2.1 Introduction

2.1.1 The Problem

Our study region is one with quite varying and complicated topography with islands and peninsulas that form part of mainland North America, separated by bodies of water of varying extent. A useful MAP analysis must assess the effects of the complicated terrain. To do this, one needs to go beyond the limited precipitation data, particularly for the data-sparse higher elevations.

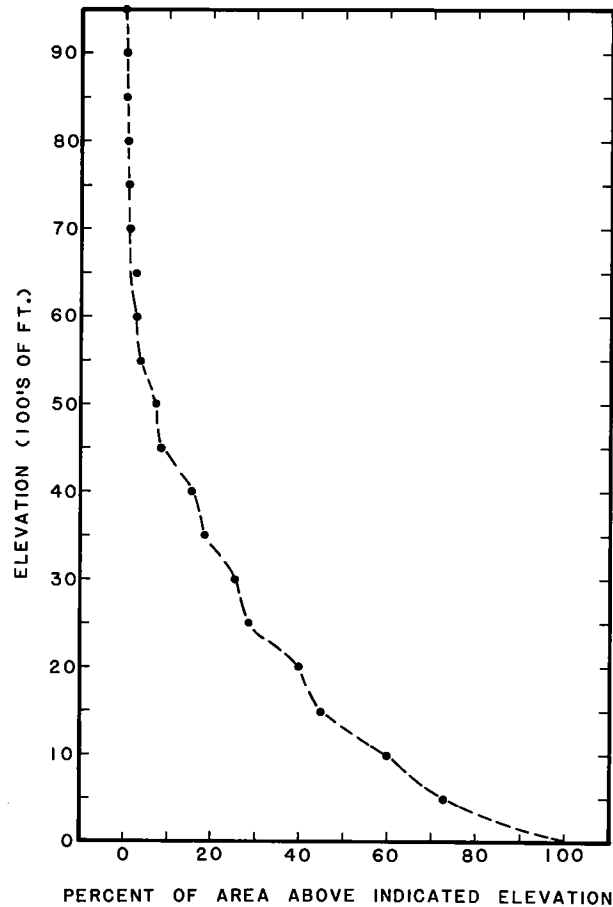

Figure 2.—Area-elevation curve.

2.1.2 Previous Studies

We reviewed two earlier MAP charts that exist covering our study area. One for southeast Alaska (Thompson 1947) was "based on sea level conditions." Although mean annual streamflow values were plotted on Thompson's map, he did not use them to estimate MAP in the mountains.

The other chart (Kilday 1974) used stations with 10 or more years of precipitation records. All of Alaska is included in Kilday's MAP chart. An isoline interval of 80 in. (2,032 mm) is used on Kilday's map for most of our study area.

2.1.3 Degree of Detail

In the present study, we concentrate on a small southeast portion of Alaska. Both this "narrowing-in" on a limited portion of Alaska and the maximum use of streamflow data justify more detail than was provided in the previous reports. The real question becomes how much detail can be justified when reliance is partially based on approximate relations with streamflow data. Another aspect of the question on detail is the need for consistency from location to location. Somewhat data-rich areas, such as those surrounding Juneau and Ketchikan, display more variability in MAP than we show on our MAP chart. However, our inability to define similarly detailed variability in less data-rich areas and the desire for consistency both suggest a lesser degree of detail across the study area than

that possible in the most data-rich areas. The tremendously complicated topography (about one-half the region is comprised of hundreds of islands of varying size) confirms the need for the emphasis on consistency of detail. Otherwise, we would be going overboard in attempting detail not justified by the data or the present state of knowledge concerning orographic effects on precipitation.

2.2 Data

2.2.1 Precipitation Data

The basic precipitation data for the study area are obtained almost exclusively from low-elevation stations. These show considerable variation from station to station, both in length of record and in the specific periods covered. We adjusted the station annual precipitation values to a common period. We chose the 30-yr period used for climatological normals, 1941-70. Station information and MAP values used are shown in table 1 and the station locations are plotted on figure 3. Since these are based upon the 30-yr period for 1941-70, the number of years of record shown in table 1 do not necessarily represent the period of record used for a particular station. For example, if an existing station with a long record actually has annual precipitation values for a total of 50 years, only the standardized 1941-70 period is used for the development of the MAP chart. Also, adjusting or normalization of a station's precipitation to the 1941-70 period in some cases involved only a few common years of record. The adjustment was done using the ratio method and nearby stations. Care was taken to maintain as similar topographic settings between stations as possible.

2.2.2 Streamflow Data

Table 2 lists the streamflow data used. Figure 4 shows outlines of the basins considered while the gaging locations were shown on figure 3. The first column in table 2 shows the U.S. Geological Survey's officially assigned gage numbers where available for the various sites. Where officially assigned numbers were not available, we assigned numbers based on the alphabetical listing. For example, number 9, Crater Creek at Port Snettisham, is simply the ninth basin listed in table 2. Where an average basin elevation was readily available, it is given in table 2. Since limited use was made of this elevation information, it was not determined for those basins where it was not available.

In the development of the MAP chart, basins that were about one-third or more covered with glaciers were of particular interest in a procedure used for estimating MAP. Hence, a column in table 2 shows the percent of the basin glacier-covered where this was estimated to comprise 30 percent or more of the drainage. Where the estimated amount is less than 30 percent, dashes are shown in table 2.

2.2.3 Snow Course Data

A limited amount of snow course data was also available for the region. Table 3 identifies the various snow course sites for which some data were available (U.S. Department of Agriculture, 1920 --) for help in the development of the MAP map. Some of these snow courses are no longer currently in use.

Table 1.—Mean annual precipitation data for southeast Alaska stations

Station	Lat.		Long.		Elevation		Length of Record		MAP		Remarks
	(°)	(')	(°)	(')	ft.	m	period	years*	in.	mm	
Angoon	57	30	134	35	35	11	1923-74	37	38	965	Breaks
Annette	55	02	131	34	110	34	1941-74	33	114	2896	
Annex Creek	58	19	134	06	24	7	1917-74	58	114	2896	
Auke Bay	58	23	134	38	42	13	1963-74	11	62	1575	
Baranof	57	05	134	50	20	6	1937-63	26	147	3734	Breaks
Beaver Falls	55	23	131	28	35	11	1948-74	27	151	3835	
Bell Island	55	55	131	35	10	3	1930-52	21	109	2769	Breaks
Calder	56	10	132	27	20	6	1917-31	13	112	2845	Breaks
Canyon Island	58	33	133	41	85	26	1936-44	9	61	1549	
Cape Decision	56	00	134	08	39	12	1941-73	33	77	1956	
Cape Spencer	58	12	136	38	81	25	1937-74	38	105	2667	
Chicagof	57	40	136	05	10	3	1952-57	6	130	3302	
Coffman Cove	56	01	132	49	10	3	1971-74	4	98	2489	
Craig	55	29	133	09	15	5	1937-53	17	111	2819	
Davis R	55	46	130	11	22	7	1933-36	4	102	2591	
Eldred Rock	58	58	135	13	55	17	1944-73	27	46	1168	Breaks
Five Finger	57	16	133	37	70	21	1944-74	31	56	1422	
L.S.											
Fortmann	55	36	131	25	132	40	1915-27	13	150	3810	
Hatchery											
Fort Tongass	54	50	130	35	20	6	1868-70	2	122	3099	Breaks
Glacier Bay	58	27	135	53	50	15	1966-74	9	81	2057	
Guard Island	55	27	131	53	20	6	1944-69	24	66	1676	Breaks
Gull Cove	58	12	136	09	18	5	1923-52	15	99	2515	Breaks
Gustavus, FAA	58	25	135	42	22	7	1923-68	32	54	1372	Breaks
Haines	59	16	135	27	175	53	1958-74	17	50	1270	
Terminal											
Hollis	55	28	132	40	15	5	1953-62	10	103	2616	
Hyder	55	57	130	02	20	6	1937-40	4	78	1981	
Jualin	58	49	135	02	710	216	1928-29	2	70	1778	
Jumbo Mine	55	13	132	30	1500	457	1917-19	2	196	4978	
Juneau City	58	18	134	24	25	8	1917-72	56	93	2362	
Juneau WBAP	58	22	134	35	12	4	1943-74	32	54	1372	
Kake	56	59	133	57	8	2	1919-74	14	56	1422	Breaks
Kasaan	55	38	132	34	28	9	1919-41	15	86	2184	Breaks
Ketchikan	55	21	131	39	15	5	1917-74	58	162	4115	
Killisnoo	57	27	134	32	25	8	1923-24	2	56	1422	
Klawock	55	36	133	06	20	6	1930-31	2	94	2388	

**Table 1.—Mean annual precipitation data for southeast Alaska stations
(Continued)**

Station	Lat.		Long.		Elevation		Length of Record		MAP		Remarks
	(°)	(')	(°)	(')	ft.	m	period	years*	in.	mm	
Klukwan	59	24	135	54	91	28	1917-19	3	21	533	
Lincoln Rock L. S.	56	03	132	46	25	8	1944-67	23	64	1626	Breaks
Linger Longer	59	26	136	17	700	213	1963-74	11	34	864	Breaks
Little Port Walter	56	23	134	39	14	4	1937-74	38	222	5639	
Moose Valley	59	25	136	03	400	122	1946-57	12	31	787	
Pelican	57	57	136	14	75	23	1967-74	8	127	3225	
Perserverance Camp	58	18	134	20	1400	427	1917-20	4	155	3937	
Petersburg	56	49	132	57	50	15	1927-74	43	106	2692	Breaks
Point Retreat Light	58	25	134	57	20	6	1946-72	26	71	1803	
Port Alexander	56	15	134	39	18	5	1949-62	14	176	4470	Breaks
Radioville	57	36	136	09	15	5	1936-51	15	100	2540	
Salmon Creek Beach	58	19	134	28	20	6	1917-20	4	90	2286	
Seclusion Harbor	56	33	134	03	20	6	1933-41	9	115	2921	
Shelter Island	58	23	134	52	10	3	1926-30	5	55	1397	
Shrimp Bay	55	48	131	22	25	8	1915-16	2	99	2515	
Sitka, FAA	57	04	135	21	15	5	1951-74	24	89	2261	
Sitka Magnetic	57	03	135	20	67	20	1917-74	57	96	2438	Breaks
Speel River	58	08	133	44	15	5	1917-30	11	139	3531	Breaks
Strawberry Point	58	14	135	38	-	-	1923-25	3	53	1346	
Sulzer (Hydaburg)	55	12	132	49	25	8	1917-28	7	142	3607	Breaks
Tenakee Springs	57	47	135	15	20	6	1950-73	5	60	1524	Breaks
Treepoint Light Stn.	54	48	130	56	36	11	1930-70	39	98	2489	
View Cove	55	04	133	04	13	4	1932-46	15	165	4191	
Wrangell	56	28	132	23	37	11	1918-74	55	80	2032	

*Actual number of years for which annual precipitation was available. All data were adjusted to the equivalent of a record for the period 1941-70.

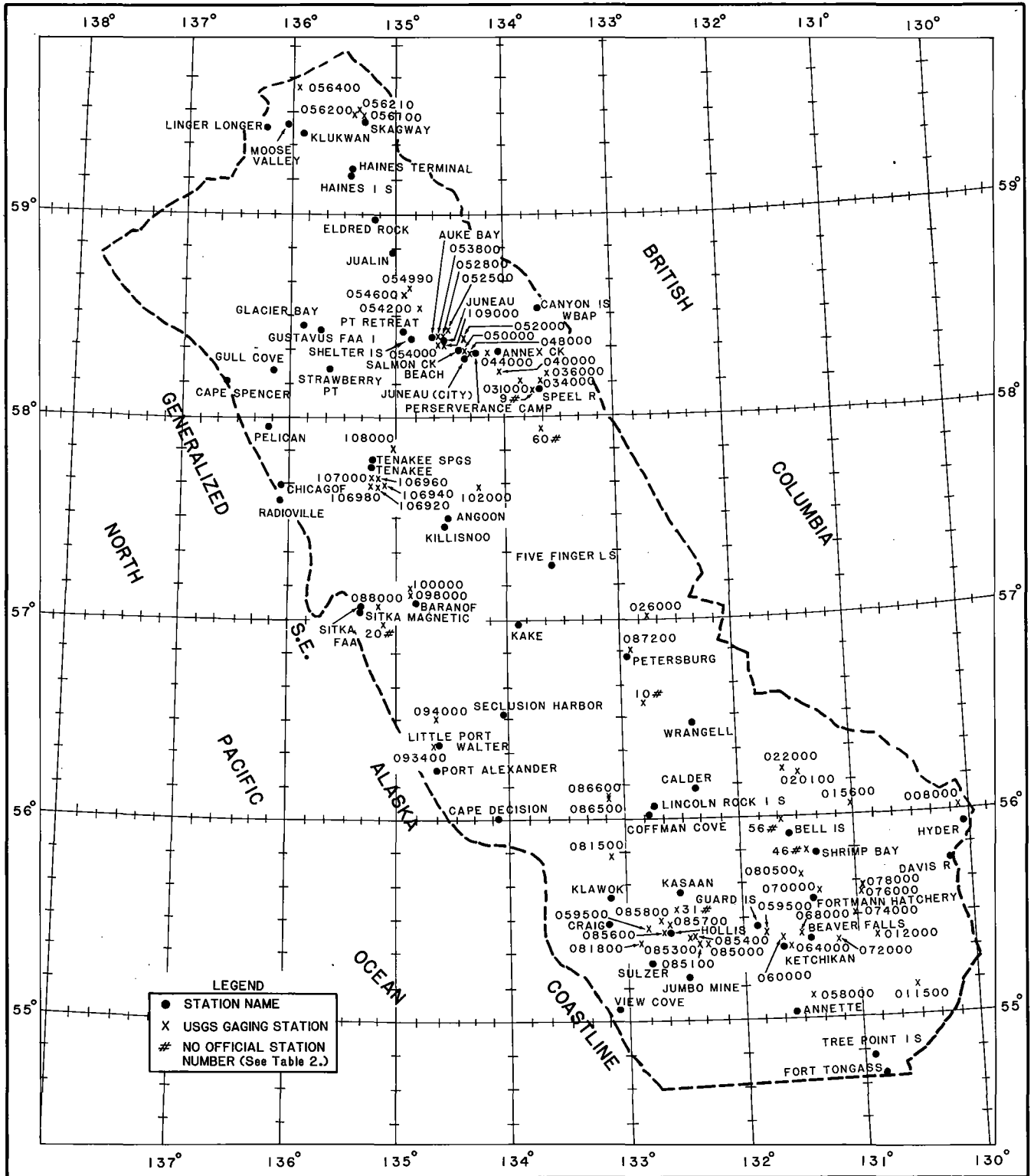

Figure 3.—Location of precipitation stations and stream gages.

Table 2.—Streamflow data used in development of mean annual precipitation map

Gage numbers*	Basin name	Gage Location				Average elevation of drainage		Drainage area		Mean runoff		Years of record	Portion of drainage (in tenths) covered by glaciers**
		Lat. (°) (')	Long. (°) (')	ft.	m	mi ²	km ²	in.	mm				
054000	Auke C. at Auke Bay	58 23	134 38	1,160	354	4	10	59	1499	15	--		
098000	Baranof River at Baranof	57 05	134 51	2,000	610	32	83	184	4674	27	--		
086600	Big C. nr. Point Baker	56 08	133 09	680	207	11	29	110	2794	11	--		
054600	Bridget Cove trib. nr. Auke Bay	58 37	134 56	400	122	1	3	45	1143	3	--		
085300	Cabin C. nr. Kasaan	55 25	132 29	N/A	N/A	9	23	133	3378	2	--		
044000	Carlson C. nr. Juneau	58 19	134 10	2,200	671	24	62	185	4699	10	--		
026000	Cascade C. nr. Petersburg	57 00	132 47	3,160	963	23	60	149	3785	38	--		
056400	Chilkat R. at gorge nr. Klukwan	59 38	135 55	4,820	1469	190	492	85	2159	5	.6		
#9	Crater C. at Port Snettisham	58 08	133 46	N/A	N/A	12	31	222	5639	12	--		
#10	Crystal C. nr. Petersburg	56 36	132 50	N/A	N/A	2	5	92	2337	13	--		
054990	Davis C. nr. Auke Bay	58 39	134 53	2,540	774	15	39	95	2413	3	--		
094000	Deer Lake Outlet nr. Point Alexander	56 31	134 40	1,300	396	7	18	291	7391	16	--		
040000	Dorothy C. nr. Juneau	58 14	134 02	3,100	945	15	39	128	3251	36	--		
074000	Ella C. nr. Ketchikan	55 30	131 01	900	274	20	52	173	4394	22	--		
070000	Falls C. nr. Ketchikan (Swan Lake)	55 37	131 21	1,800	549	37	96	171	4343	28	--		

*Number assigned by U.S. Geological Survey unless otherwise indicated (see Appendix A).

**Dashes in this column indicate less than 0.3 glaciers covered.

N/A not available.

#Station number assigned for this station as no official station number exists, data from Federal Power Commission. (see Appendix A).

Table 2.—Streamflow data used in development of mean annual precipitation map - Continued

Gage numbers*	Basin name	Gage Location				Average elevation of drainage		Drainage area		Mean runoff		Years of record	Portion of drainage (in tenths) covered by glaciers**
		Lat. (°) (')	Long. (°) (')	ft.	m	mi ²	km ²	in.	mm				
109000	Fish C. nr. Auke Bay	58 20	134 35	1,600	488	14	36	78	1981	16	--		
072000	Fish C. nr. Ketchikan	55 24	131 12	1,300	396	32	83	179	4547	56	--		
050000	Gold C. at Juneau	58 18	134 24	2,400	732	10	26	149	3785	31	--		
078000	Grace C. nr. Ketchikan	55 39	130 07	1,500	457	30	78	188	4775	16	--		
#20	Green Lake at Silver Bay nr. Sitka	56 59	135 05	N/A	N/A	31	80	129	3277	10	--		
087200	Hammers Slough at Petersburg	56 48	132 57	N/A	N/A	1	3	88	2235	3	--		
022000	Harding R. nr. Wrangell	56 13	131 38	2,400	732	67	174	148	3759	22	.3		
085700	Harris R. nr. Hollis	55 28	132 42	1,400	427	29	75	120	3048	15	--		
102000	Hasselborg C. nr. Angoon	57 40	134 15	1,200	366	56	145	78	1981	16	--		
054200	Herbert R. nr. Auke Bay	58 32	134 48	2,820	860	57	148	135	3429	5	.8		
106940	Hook C. above trib.	57 41	135 08	1,260	384	4	10	94	2388	7	--		
106960	Hook C. nr. Tenakee	57 41	135 10	1,160	354	8	21	71	1803	8	--		
085600	Indian C. nr. Hollis	55 27	132 42	1,000	305	9	23	132	3353	15	--		
106920	Kadashan R. above Hook C.	57 40	135 11	1,020	311	10	26	88	2235	6	--		
107000	Kadashan R. nr. Tenakee	57 42	135 13	970	296	38	98	85	2159	10	--		
#31	Karta R. at Karta Bay	55 33	132 35	N/A	N/A	49	127	126	3200	7	--		
064000	Ketchikan C. at Ketchikan	55 21	131 38	1,280	390	14	36	207	5258	10	--		
015600	Klahini R. nr. Bell Island	56 03	131 03	2,790	850	58	150	125	3175	6	--		
053800	Lake C. at Auke Bay	58 24	134 38	1,170	357	3	8	70	1778	10	--		
052000	Lemon C. nr. Juneau	58 24	134 25	3,430	1045	12	31	173	4394	21	.4		
031000	Long R. above Long Lake	58 11	133 53	3,020	920	8	21	175	4445	9	.4		
034000	Long R. nr. Juneau	58 10	133 42	2,400	732	33	85	192	4877	37	.4		
068000	Mahoney C. nr. Ketchikan	55 26	131 31	1,680	512	6	16	260	6604	23	--		
076000	Manzanita C. nr. Ketchikan	55 36	130 59	1,300	396	34	88	191	4851	30	--		

Table 2.—Streamflow data used in development of mean annual precipitation map - Continued

Gage numbers*	Basin name	Gage Location				Average elevation of drainage		Drainage area		Mean runoff		Years of record	Portion of drainage (in tenths) covered by glaciers**
		Lat. (°)	Long. (')	Lat. (°)	Long. (')	ft.	m	mi ²	km ²	in.	mm		
085800	Maybeso C. at Hollis	55	29	132	41	1,120	341	15	39	123	3124	14	--
052500	Mendenhall R. nr. Auke Bay	58	25	134	33	3,260	994	85	220	172	4369	9	.8
052600	Montana C. nr. Auke Bay	58	24	134	36	1,500	457	16	41	90	2286	9	--
081800	NB Trocadero C. nr. Hydaburg	55	22	132	52	1,050	320	17	44	119	3023	6	--
086500	Neck C. nr. Pt. Baker	56	06	133	08	500	152	17	44	99	2515	7	--
085100	Old Tom C. nr. Kasaan	55	24	132	24	1,000	305	6	16	86	2184	25	--
#48	Orchard C. at Shrimp Bay	55	50	131	27	N/A	N/A	59	153	132	3353	12	--
108000	Pavlof R. nr. Tenakee	57	51	135	02	900	274	24	62	91	2311	17	--
060000	Perserverance C. nr. Wacker	55	25	131	40	1,340	408	3	8	179	4547	31	--
058000	Purple Lake outlet nr. Metlakatla	55	06	131	26	860	262	7	18	176	4470	9	--
011500	Red R. nr. Metlakatla	55	08	130	32	1,700	518	45	117	177	4496	10	--
008000	Salmon R. nr. Hyder	56	02	130	04	3,900	1189	84	218	155	3937	10	.6
085000	Saltery C. nr. Kasaan	55	24	132	19	N/A	N/A	6	16	144	3658	2	--
093400	Sashin C. nr. Big Port Walter	56	23	134	40	1,130	344	4	10	284	7214	8	--
088000	Sawmill C. nr. Sitka (Medvetcha R.)	57	03	135	14	2,400	732	39	101	170	4318	28	--
048000	Sheep C. nr. Juneau	58	17	134	19	1,900	579	5	13	144	3658	34	--
#56	Shelokum Lake outlet at Bailey Bay	55	59	131	39	N/A	N/A	17	44	174	4420	9	--
056100	Skagway R. at Skagway	59	27	135	19	3,900	1189	145	376	47	1194	12	.4
036000	Speel R. nr. Juneau	58	12	133	37	3,100	945	226	585	157	3988	16	.4
081500	Staney C. nr. Craig	55	49	133	08	850	259	52	135	96	2438	10	--

Table 2.—Streamflow data used in development of Mean Annual Precipitation Map - Continued

Gage numbers*	Basin name	Gage Location				Average elevation of drainage		Drainage area		Mean runoff		Years of record	Portion of drainage (in tenths) covered by glaciers**
		Lat. (°)	Lat. (')	Long. (°)	Long. (')	ft.	m	mi ²	km ²	in.	mm		
#60	Sweetheart Falls Cr. at Pt. Snettisham	57	57	133	41	N/A	N/A	27	70	171	4343	10	--
056210	Taiya River nr. Skagway	59	31	135	21	4,820	1469	179	464	80	2032	5	.5
100000	Takatz C. nr. Baranof	57	09	134	52	2,300	701	18	47	202	5131	18	.3
106980	Tonalite C. nr. Tenakee	57	41	135	13	950	290	15	39	91	2311	5	--
080500	Traitors Creek nr. Bell Island	55	44	131	30	N/A	N/A	21	54	97	2464	3	--
020100	Tyee C. at mouth nr. Wrangell	56	13	131	30	2,620	799	16	41	148	3759	8	--
085400	Virginia C. nr. Kasaan	55	26	132	26	N/A	N/A	3	8	57	1448	2	--
056200	West C. nr. Skagway	59	32	135	21	3,400	1036	43	111	103	2616	12	--
059500	Whipple C. nr. Ward Cove	55	27	131	48	880	268	5	13	97	2464	6	--
012000	Winstanley C. nr. Ketchikan	55	25	130	52	1,730	527	16	41	138	3505	29	--

(See legend on page 1 of this table).

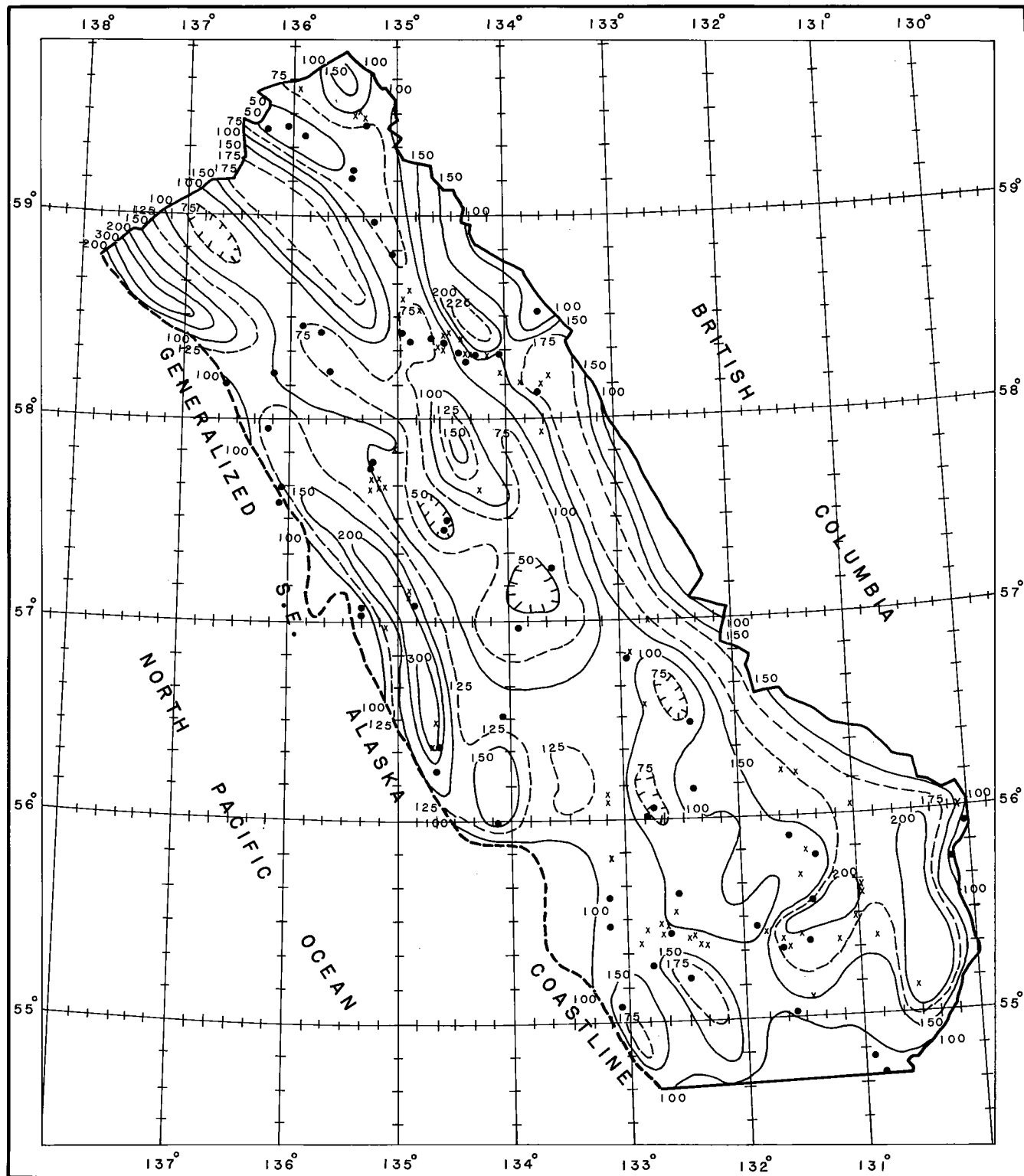

Figure 4.—Outline of basins whose data were used to aid in development of mean annual precipitation chart.

Table 3.—Location of snow course locations used in this study

Snow course name	Lat.		Long.		Elevation	
	(°)	(')	(°)	(')	ft	m
Upper Long Lake	58	11	133	43	1,000	305
Long Lake	58	12	133	47	1,080	329
Speel River	58	09	133	43	280	85
Crater Lake	58	08	133	43	1,750	533
Harriet Top	55	29	131	37	2,000	610
Hunt Saddle	55	30	131	37	1,500	457
Lake Shore	55	29	131	36	660	201
Wolverine Glacier	60	25	148	55	4,430	1,350

2.2.4 Upper Air Temperature Data

Judgment on the magnitude of MAP for some locations came from analyses of small glaciated areas (sec. 2.4). For this analysis mean upper air temperatures at selected heights were used. The monthly temperature means for Juneau are tabulated in table 4 (Ratner 1957). These data were chosen as an upper air index to mean temperatures.

Table 4.—Mean upper air temperatures for Juneau (after Ratner, 1957)

Height (mb)	Month											
	J	F	M	A	M	J	J	A	S	O	N	D
	Temperature °C*											
950	-6.6	-4.2	-1.4	1.8	6.6	10.6	12.0	11.7	9.4	4.3	-0.2	-3.1
900	-9.0	-6.4	-4.4	-1.4	3.3	7.1	8.9	8.8	6.6	1.5	-2.6	-5.5
850	-11.2	-8.6	-7.4	-4.7	0.2	4.1	5.7	5.8	3.6	-1.5	-5.1	-8.0
800	-13.1	-10.5	-10.1	-7.8	-2.7	1.2	3.0	3.0	1.0	-4.3	-7.3	-10.3

*°F can be determined from the equation $^{\circ}\text{F} = \frac{9}{5} (^{\circ}\text{C}) + 32$

2.3 First Approximation to Mean Annual Precipitation

The approach used consisted of: (a) deriving a first approximation MAP as described in this section, and (b) checking, and adjusting this analysis through a technique that uses the existence and/or nonexistence of small snowfields or glaciers as described in section 2.4.

2.3.1 Guidelines for First Approximation

The following guidelines were set up for the analysis of the MAP:

- a. A primary aim was uniformity of detail.

There are two alternatives. First, a detailed analyses would be completed in relatively data dense regions such as in the vicinity of Juneau, Ketchikan, and on a portion of Baranof Island (e.g., streamflow from several adjoining

basins--see fig. 10). Then, in data sparse regions detailed analyses would be based on the limited data and topographic and meteorologic similarities. The second alternative would be to space average or smooth-out some of the variability shown by the data in the regions around Juneau, etc. This latter methodology was adopted for this study.

- b. Where rainfall and streamflow measurements in close proximity appear to conflict, generally the rainfall measurements were given preference. This general preference rule was not applied inflexibly since, in concert with the first principle of consistency of detail, some locations with higher density of rain gage measurements (e.g., near Juneau) were not as useful in terms of smooth generalizations as were nearby streamflow measurements.
- c. The overall losses due to transpiration, etc., are generally less in Southeast Alaska than in the contiguous United States. We assume this difference is the result of predominance of moist air masses in southeast Alaska which limit transpiration losses.
- d. The degree of detail in the 1:1,000,000 scale topographic map was used for analysis of the MAP. Further smoothing is introduced by use of a generalized elevation chart (fig. 5).

2.3.2 Analysis

Following the guidelines in section 2.3.1 a chart of MAP was analyzed. The degree of smoothing around data-rich areas is evident if one looks at the plotted data and analyzed map (fig. 6) in areas near Juneau and Ketchikan. The uniformity of detail was aided by use of the generalized elevation contour analysis (fig. 5). This analysis was the primary orographic base used for the initial MAP analysis.

The first approximation map was closely drawn to most of the adjusted precipitation data (sec. 2.2.1). A few short-record precipitation stations with data that were from the years before 1930 were not amenable to adjustment to a 1941-70 normal, and so these carried less weight in the overall analysis. Shrimp Bay, near the southern end of our study area (fig. 3), with a 2-yr record (1915-16) was located in a region of relatively plentiful data and its MAP was enveloped. However, in a few cases (of short records) such as the 4-yr record at Davis River, useful information was provided for data-deficient areas. A qualitative relation with topography was maintained by using this as an underlay during the MAP analysis. Though precipitation data were inadequate to develop a specific quantitative elevation-precipitation relation, knowledge from other regions suggested some increase in MAP with elevation. This subjective relation is evident in the analyzed final chart (fig. 6).

Streamflow data provided an extremely valuable supplement to the precipitation data. Helping in this regard were: (a) a classification of quality of records, (b) a check on the stability of the records based upon their length, and (c) the

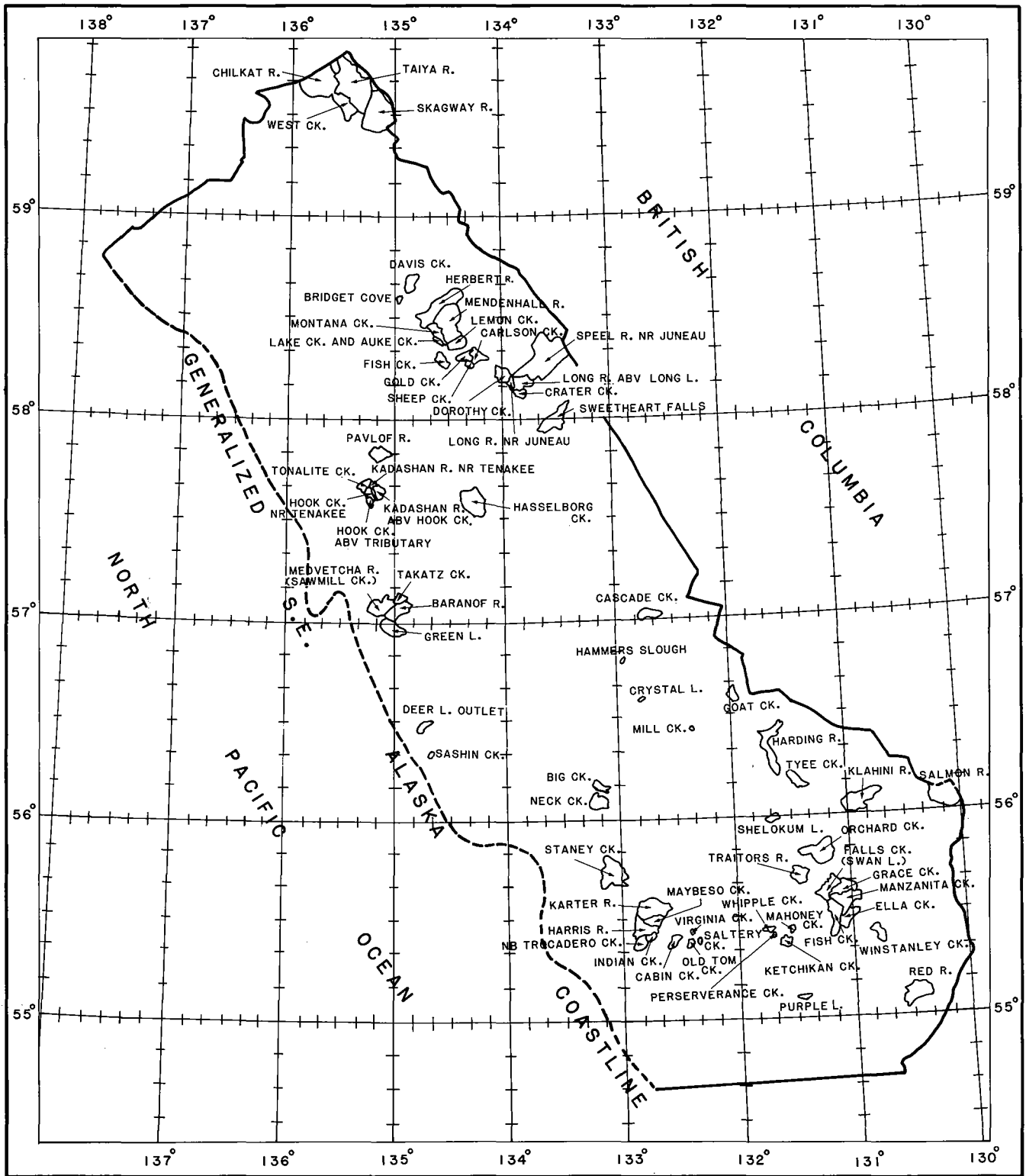

Figure 5.—Generalized evaluation contours for southeast Alaska. Labels are in 1000's of feet.

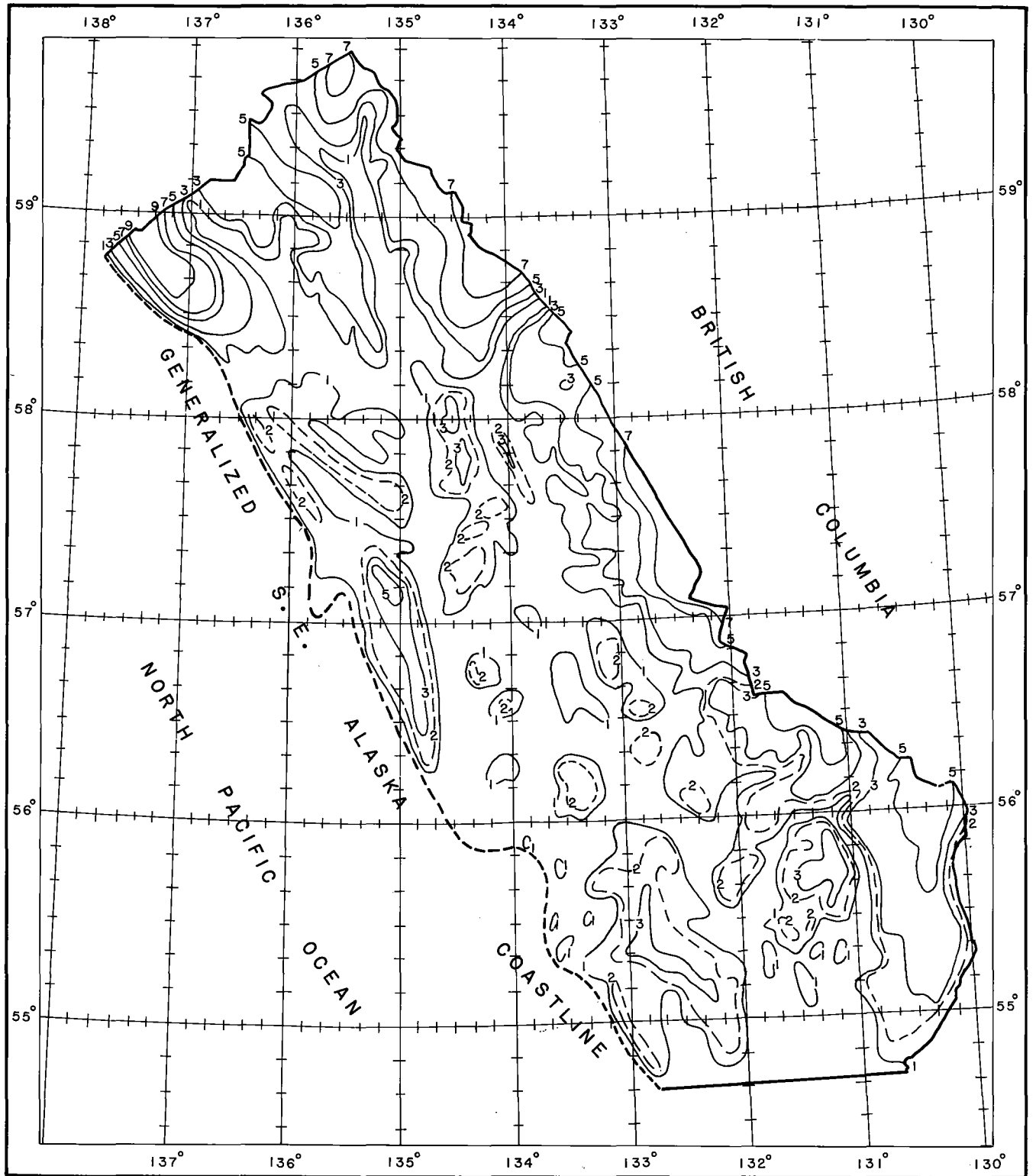

Figure 6.—Mean annual precipitation chart (inches) for southeast Alaska.

existence of streamflow records from stations in close proximity that have similar topography (e.g., fig. 10).

The Manzanita Creek drainage (see table 2), using the normalized record, showed a mean seasonal runoff of 191 in. (4851 mm). The nearby drainages of Ella Creek, Grace Creek, and Falls Creek (see fig. 4 for locations), all with shorter records, showed overall good consistency in magnitude of runoff in reference to existing orography. On the interior upslopes, streamflow data were limited, but still provided valuable information for analysis. For example, two drainages with rather long records, Cascade Creek (141 in., 3581 mm) and the Harding River (148 in., 3759 mm) near Wrangell, provided good consistency in this region where precipitation measurements were absent.

Even the short record streamflow data were generally of use, again mainly through evidence of internal consistency. For example, the 286-in. (7264-mm) runoff for a short 3-yr record at Deer Lake Creek outlet would, by itself, be of limited usefulness. However, the nearby 8-year record at Sashin Creek with runoff of 284 in. (7214 mm) provided valuable consistent support. Also, the MAP measured at the nearby station of Little Port Walter is 222 in. (5639 mm). These mean runoff and precipitation measurements with topographic considerations suggested an analysis that showed at least 300 in. (7820 mm) of MAP at the higher elevations in this portion of Baranof Island. The smoothed analysis resulted in an envelopment of the observed precipitation value for Little Port Walter.

The agreement of streamflow and precipitation data in the regions cited as well as in others where both were available supported the use of streamflow data alone as a reasonable lower limit where precipitation data were not available.

2.4 Adjustments to Mean Annual Precipitation Chart Based on Analysis of Data from Small Snow Fields or Glaciers

It was our opinion that massive glaciers are not good indicators of variations in MAP amounts at various elevations since snow accumulations at high elevations may move through glacial processes to considerably lower elevations. However, in Southeast Alaska there are, in addition to massive glaciers, numerous areas where relatively small snow fields, or glaciers, barely persist through the warm season. In spite of recognized uncertainties, such restricted snowfields may provide some help in making adjustments to first approximation estimates of MAP. The size and type of snow field selected are quite important to the technique. It must be small enough to be indicative of a "balance." By "balance" we mean the small snowfields or glaciers show that the accumulated snowpack just barely disappears, for all practical purposes, as a new seasonal snowpack begins to form in the fall. In addition to the careful selection of the type and size of small glaciers, two basic relations needed to be developed. These are:

- a. A relation telling how much of the MAP normally can be expected to accumulate as snowpack, and
- b. A relation telling how much snowpack can melt in a normal season.

Both relations depend significantly on elevation and prevailing temperatures. The development of the first relation involves two parts. First the length of accumulation period versus elevation was determined. Then values of MAP were introduced so that accumulation could be related to MAP. Thus, given a MAP and elevation for a particular location, one may obtain the snowpack. For development of the second relation, both empirical and theoretical approaches were used to relate snowmelt to season and elevation.

2.4.1 Accumulation Season Versus Elevation

This section describes how we approximated the length of the snow accumulation season as a function of temperature and elevation.

2.4.1.1 Temperature Data. Temperature data discussed in 2.2.4 were used to develop the variation in length of precipitation accumulation season versus elevation. Several simplifying assumptions are used in the development. These are:

- a. The accumulation season, at a given elevation, is assumed to be defined as the period of the year during which the mean daily free air temperature is freezing (0°C or 32°F) or below.
- b. The melt season starts (ends) the first day the mean daily temperature rises above (falls below) freezing.
- c. All precipitation was assumed to accumulate in the snowpack during the accumulation season.

Figure 7 shows our analysis of the upper air temperature data used for determining the variation of accumulation season with elevation. From a temperature analysis at standard pressure levels, curves were drawn for the 1,000-, 2,000-, 3,000-, 4,000-, 5,000, and 6,000-ft (305-, 610-, 914-, 1,220-, 1,524 and 1829-m) levels (fig. 7). The accumulation seasons (rounded to half months) for these elevations are tabulated in table 5.

2.4.1.2 Precipitation Data. In order to work out the percentages of MAP to be assigned to the accumulation seasons of table 5, monthly precipitation data from nine stations were used (1941-70). Table 6 shows normal monthly precipitation values for each station and the sum for the nine stations. These monthly sums are then shown as a percent of the MAP for the nine stations. Both the airport data and the city office data at Juneau were used even though they are in close proximity, because large precipitation differences exist which reflect differing orographic effects. In spite of these differences, the monthly percents of MAP do not differ significantly for the two locations.

We then evaluated whether it was appropriate to use the monthly percents of MAP (of table 6) for all elevations. Monthly precipitation records were available for only two stations in southeast Alaska at elevations significantly above sea level. These were at Jumbo Mine (1,500 ft, 457 m) with a little over 3 years of record, and Perserverance Camp (1,100 ft, 335 m) with about a 7.5-yr record. Monthly means (percent of seasonal precipitation) were determined for these two short-record stations. These were within the range of the means for the nine stations used in table 6, except for August and November (higher percents) and

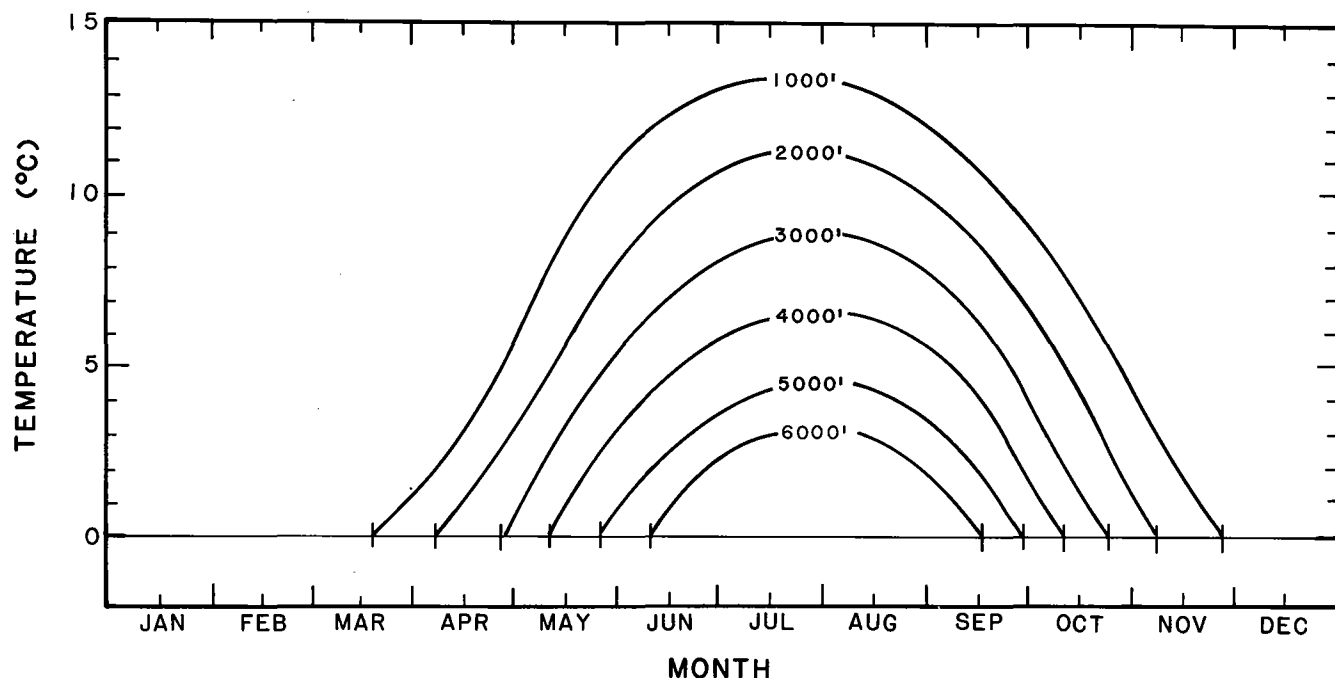

Figure 7.—Analysis of upper air temperature based upon Juneau (after Ratner).

Table 5.—Snowpack accumulation season

Height		Duration of accumulation season
ft	m	
1,000	305	December 1 - March 15
2,000	610	November 15 - April 15
3,000	914	November 1 - April 30
4,000	1220	October 15 - May 15
5,000	1524	October 1 - May 31
6,000	1829	September 15 - June 15

September (lower percents). The November value for Jumbo Mine differed most from the nine-station mean (table 6) because a single very large November value of 61.46 in. (1561 mm) in 1918 distorted November's monthly mean. Using the average precipitation of the other two years, the percentage for November is very close to the nine-station mean. We conclude the monthly percentage of mean annual precipitation (table 6) can be used for all elevations.

2.4.1.3 Accumulation Season Percentages Versus Elevation. The mean monthly percentages of table 6 were summed to determine the percent of MAP for the accumulation season (table 5) at each elevation. Where beginnings or endings of an accumulation period were at midmonth, one-half of that month's percentage contribution to the MAP were used in the summation. Results are shown in table 7.

Table 6.—Monthly contributions to mean annual precipitation

Station	Elevation ft m		Precipitation amount													
			Month												Annual	
			Jan	Feb	Mar	Apr	May	Jun	Jul	Aug	Sep	Oct	Nov	Dec		
Cape Spencer	81	25	in. mm	7.60 193	6.22 158	6.69 170	5.54 141	6.09 155	4.75 121	6.80 173	8.90 226	13.93 354	16.08 408	13.77 350	9.81 249	106.18 2697
Juneau No. 2	25	8	in. mm	6.89 175	6.16 156	6.42 163	5.99 152	5.61 142	4.09 104	6.43 163	7.61 193	11.03 280	13.36 339	10.00 254	8.39 213	91.98 2336
Juneau WSO (AP)	12	4	in. mm	3.94 100	3.44 87	3.57 91	2.99 76	3.31 84	2.93 74	4.69 119	5.00 127	6.90 175	7.85 199	5.53 140	4.52 115	54.67 1387
Ketchikan	15	5	in. mm	15.06 383	12.74 324	12.15 309	12.88 327	8.62 219	7.20 183	8.48 215	11.27 286	15.29 388	24.77 629	17.63 448	16.18 411	162.27 4122
Little Pt Walter	14	4	in. mm	20.65 525	17.51 444	16.33 415	14.33 364	11.58 294	8.13 207	9.06 230	13.48 342	24.06 611	34.32 872	26.78 680	24.99 635	221.22 5619
Peters- burg	50	15	in. mm	9.31 236	7.48 190	6.98 177	7.10 180	5.78 147	4.82 122	5.57 141	7.31 186	11.26 286	17.51 445	11.68 297	10.79 274	105.59 2682
Sitka Magnetic	67	20	in. mm	8.21 209	6.68 170	7.45 189	5.62 143	4.69 119	3.45 88	5.11 130	7.20 183	11.44 291	14.30 363	11.28 287	10.07 256	95.50 2426
Wrangell	37	11	in. mm	6.85 174	5.76 146	5.50 140	5.02 128	3.93 100	3.89 99	5.12 130	6.19 157	8.66 220	12.93 328	9.08 231	7.64 194	80.57 2046
Yakutat WSO (AP)	28	9	in. mm	10.36 263	9.28 236	9.57 243	7.65 194	8.02 204	5.68 144	8.46 215	10.81 275	15.45 392	19.52 496	14.80 376	12.86 327	132.46 3364
Sum - in. mm				88.87 2257	75.27 1912	74.66 1896	67.12 1705	57.63 1464	44.94 1141	59.72 1517	77.77 1975	118.02 2998	160.64 4080	120.55 3062	105.25 2673	1050.44 26681
Mean % of mean annual				8.46	7.17	7.16	6.30	5.49	4.28	5.68	7.40	11.23	15.29	11.48	10.02	100

Table 7.—Accumulation season snowpack water equivalent in percent of mean annual precipitation

Elevation		Snowpack water equivalent percent of MAP
ft	meters	
1,000	305	29
2,000	610	42
3,000	914	51
4,000	1,220	61
5,000	1,524	71
6,000	1,829	79

Interpolation by elevation and MAP can be accomplished through figure 8. The sloping lines on this figure (inches of MAP) are the MAP values at the indicated elevations that would produce the snowpack (water-equivalent) values shown on the abscissa. As an example of its use at an elevation of 3,000 ft (914 m) a snowpack water equivalent of 100 in. (2540 mm) requires a MAP of 196 in. (4978 mm). This comes from dividing the 100 in. (2540 mm) by .51 (the .51 being the 3,000-ft, 914 m) accumulation season portion of the MAP from table 7).

2.4.2 Development of Melt Curve for Small Glaciated Areas

We define the melt curve as the relation of the potential snowmelt at each elevation that would exist if enough snow were available at that elevation for melting through the melt season. The melt season (see section 2.4.1.1) is assumed to be the season when the mean daily temperature is above 32°F (0°C). Thus, the melt season plus the accumulation season (see section 2.4.1.1) equals the entire year. For practical purposes, a melt curve for low elevations where the prevailing melt season is long is a theoretical or "potential" melt curve only. Not enough snow can accumulate at the lower elevations to survive the entire melt season. This is true (the melt curve is a theoretical curve only) for nearly all locations in the study area below about 2,000 ft (610 m). The exceptions, of course, would be those areas where glaciers flow to below 2,000 ft (610 m) or lower from higher elevations. Above about 3,000 ft (914 m), there are numerous areas where enough precipitation actually accumulates to permit melting for the full melt season. For such areas the melt curve then becomes an "actual" melt curve.

Our interest is in developing a melt curve for elevations between 2,000 ft (610 m) and 6,000 ft (1,829 m) as a supplement to streamflow and precipitation measurements for refining the MAP. The curve is actually developed down to 1,000 ft (305 m) since theoretical computations for low elevations can help in "firming up" the shape of such a curve above 1,000 ft (305 m).

2.4.2.1 Purpose:

The purpose of the melt curve is to use it with the information from figure 8 to do the following:

- a. Estimate MAP, or revise first approximation MAP estimates, particularly in data-sparse areas in southeast Alaska.

ACCUMULATION
SEASON % OF
ANNUAL PCPN.

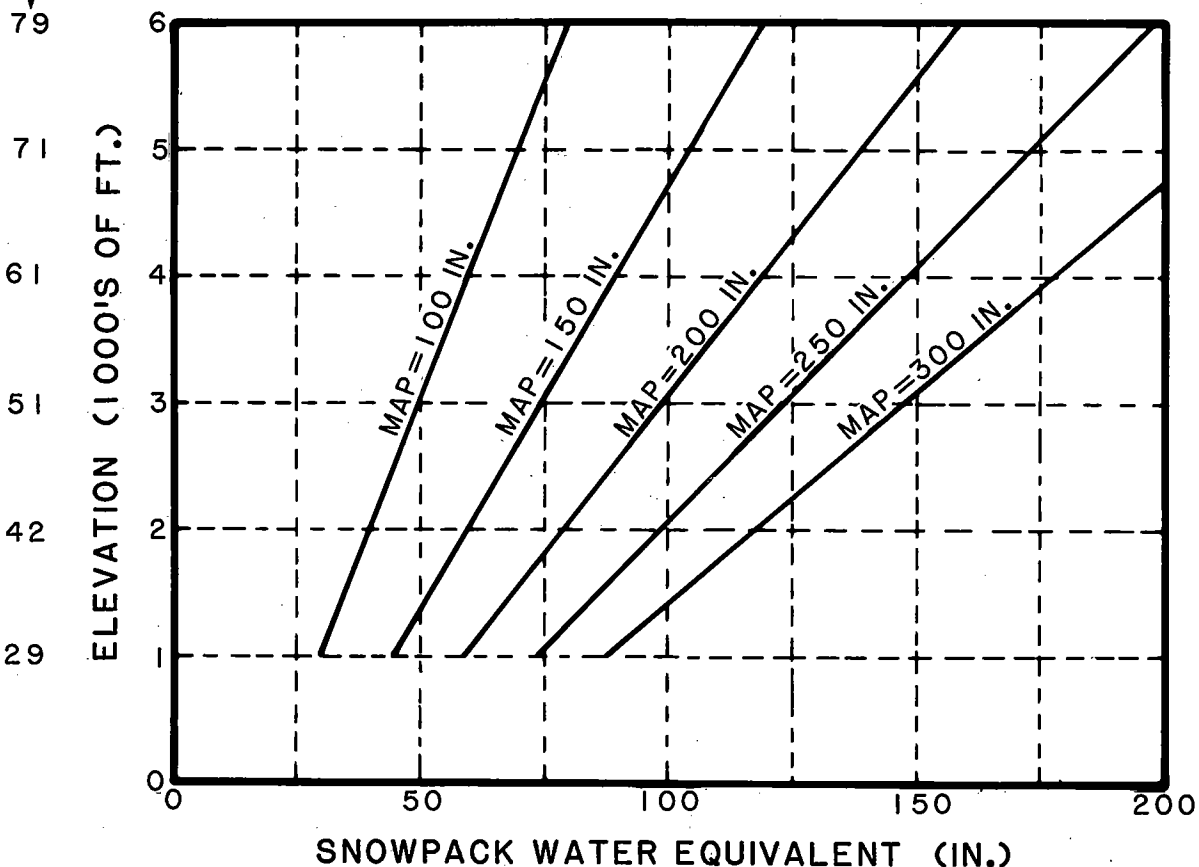

Figure 8.—Variation of snowpack water equivalent with elevation and mean annual precipitation.

- b. Check the first approximation estimate on the basis of lack of small glaciated areas. That is, answer the question, "is the first approximation MAP too high in some areas?"
- c. Check the first approximation estimate on the basis of the existence of small glaciated areas. Is it too low in some areas?

2.4.2.2 Definition of Usable Glaciated Areas. In order to be usable with the relation shown in figure 8 and to help define the melt curve, glaciated areas must have the following characteristics:

- a. Ideally, such areas ought to be quite small, about 1 mi² (2.6 km²) or less. This is necessary in order to assume that a balance exists, that is, in the mean, the accumulation of snow is just enough to provide all that can possibly melt.

- b. If snowfields or small glaciers larger than 1 mi² (2.6 km²) are used, great care must be exercised in their use and interpretation in terms of balanced conditions.
- c. Usually when b. applies, and sometimes when a. applies, in order to determine whether or not particular areas qualify, detailed topographic maps are used to eliminate those cases where the terrain (e.g., narrow valleys with steep adjoining slopes) permit snowfields or small glaciated snow to collect or extend to unrealistically low elevations. By unrealistic we mean the snow extends to a lower elevation than that responsible for its formation and accumulation.

With the above criteria in mind, we need to recognize that a particular small glaciated or snow-covered area may qualify as an entity embracing a small elevation range or may qualify in part (i.e., not the whole area, even though small). It was necessary to use 1:63,360 scale topographic charts for appropriate definition of useable glaciated areas and for elevations.

2.4.2.3 Data Used in Development of Melt Curve. The data which played a part in the derivation of the melt curve consisted of the following:

- a. Selected areas (mostly in the 3,000- to 5,000-ft or 914- to 1,524-m range in elevation) where an approximate "balance" between accumulated snowpack and melt could be substantiated by existing data.
- b. Theoretical computations using a degree-day melt factor and free-air temperature data for the 950-mb level (a close-to-surface level where other types of data are deficient). This approach plus a composite of empirical data referred to below in c. provide the means of fixing of the curve at low elevations.
- c. Corollary support both for amount of melt and shape of melt versus elevation curve came from free-air temperature, runoff, and snow course data.

2.4.2.4 Analysis with Empirical Fixes From "Balanced" Data-Supported Areas. Trapezoids were constructed from the supporting data for the positioning of the melt curve in the 3,000- to 5,000-ft (914- to 1,524-m) elevation range. Figure 9 illustrates this for the Baranof drainage. The inset shows four locations. Those identified as 1 and 2 are small areas (approximately 2 to 3 mi²) that were selected randomly and show the range in elevations, MAP, and accumulated water equivalent values that could be found over small areas in southwest Alaska. To attempt to pin such data to points would be unrealistic. "A" and "B" on the inset identify the sample regions where "balanced" conditions exist as indicated by small perennial glaciers or snowfields. Snowfield A lies between a range of elevations from about 3,000 ft (914 m) to 5,000 ft (1,524 m). The size of this small glacier or snowfield, although not massive, is sufficiently great to cover this range of elevations, but the highest elevations to the windward of the

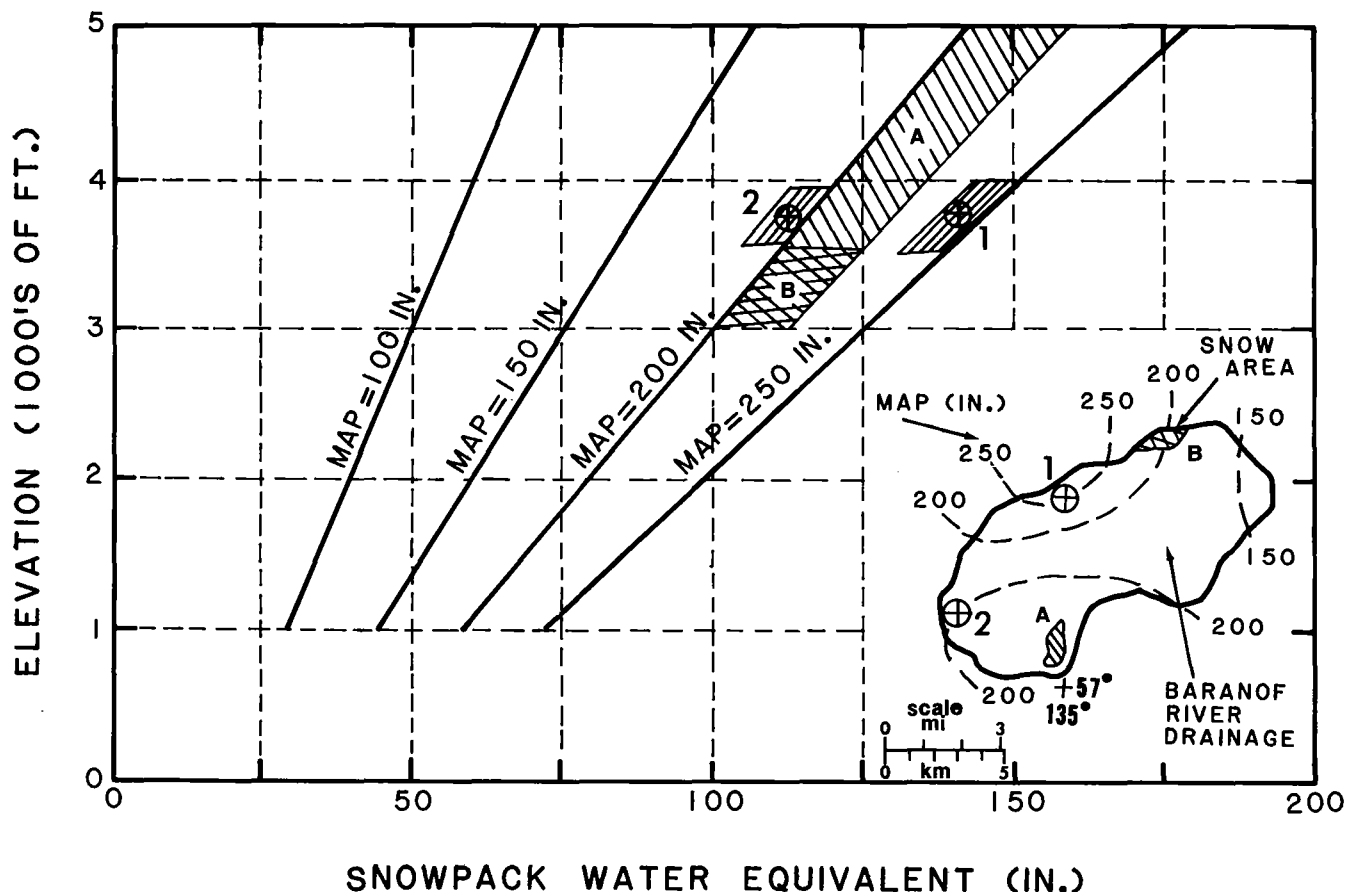

Figure 9.--Examples of parallelograms for balanced areas.

glaciers are likely most representative of the snow production. Area B with elevations of 3,500 to 4,000 ft (1,067 to 1,220 m) is overlapped by the larger elevation range of area A. The assigned MAP values for the parallelograms were derived from the analysis of MAP over the Baranof River drainage and adjoining basins. How this more detailed analysis for the Baranof drainage and adjacent basins fits into the broader picture MAP generalization is shown in figure 10.

Figure 11 summarizes both the snow and no-snow small glacial data in terms of the centers of the parallelograms. Each dot represents a center of a parallelogram such as the two shown in figure 9. Each such parallelogram represents a "balance" area as indicated by close to complete disappearance of snowpack (i.e., small glaciers or snowfields). Each "x" represents the center of a parallelogram where even the higher elevation portions of the basin showed no snow (indicative of melt exceeding accumulation). Thus, the purposes set forth in section 2.4.2.1 are fulfilled. Each individual "." and "x" has a subscript which identifies the drainage basin outlined on figure 10. These subscripts are:

- B. Baranof River Drainage
- T. Takatz Creek Drainage
- G. Green Lake Drainage
- S. Sawmill Creek

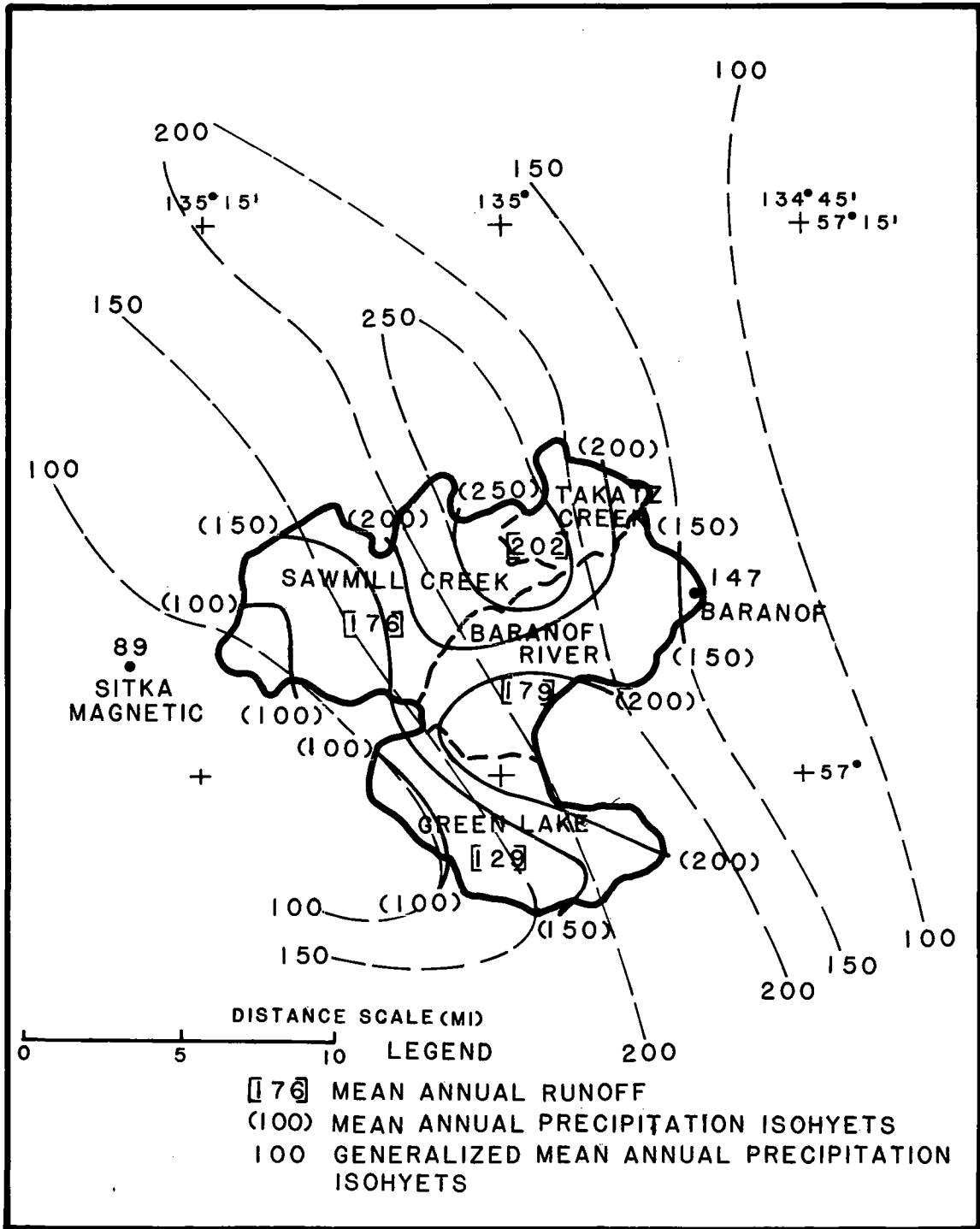

Figure 10.—Analysis of mean annual precipitation (inches) with adjoining basin runoff as input.

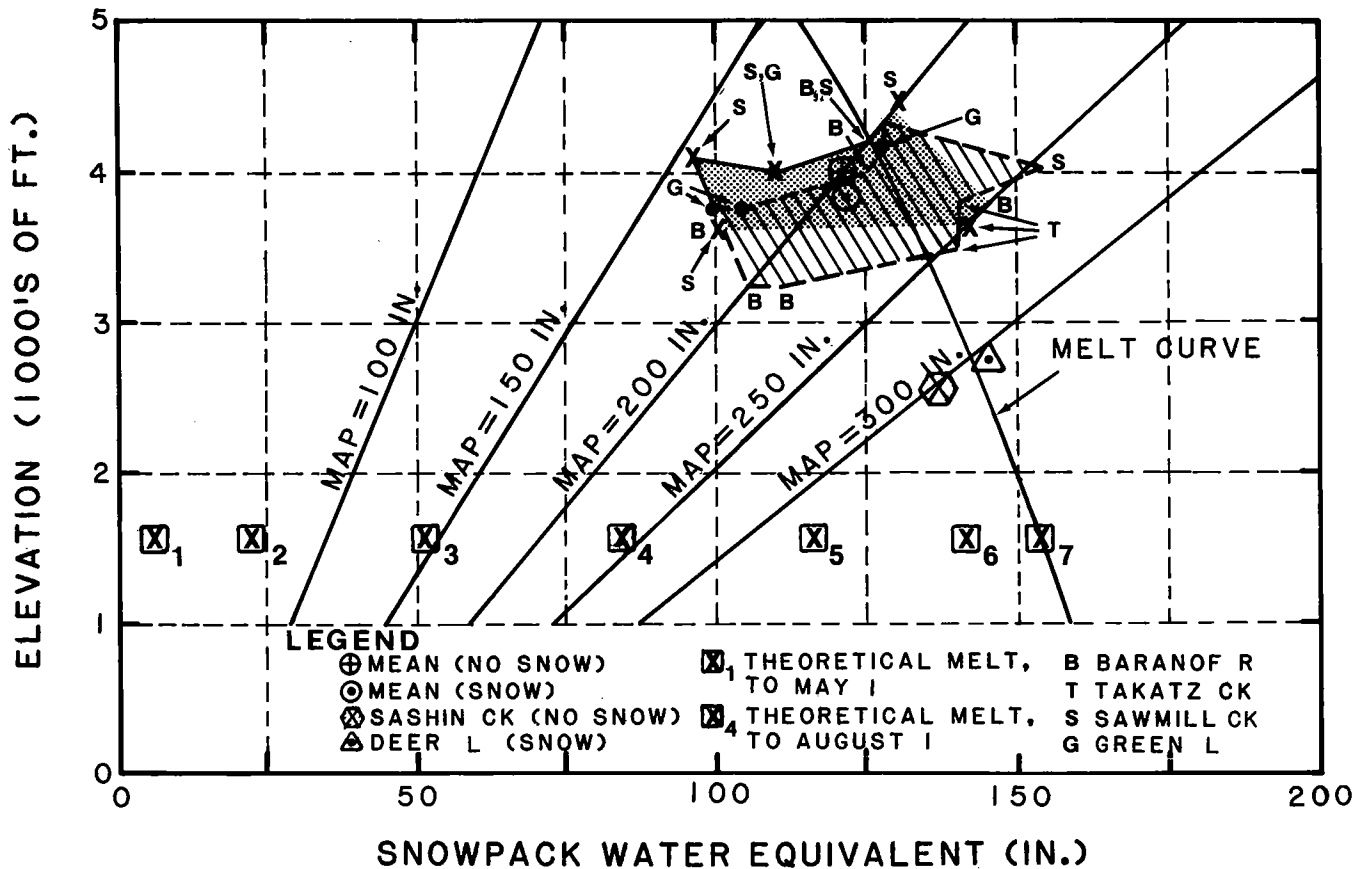

Figure 11.—Melt curve from balanced areas.

An enveloping area is outlined by connecting all the "snow" means (purpose c. under 2.4.2.1) and another doing the same with the "no-snow" means (purpose b. under 2.4.2.1). Overall means, giving each point equal weight, are shown on figure 11.

The Deer Lake and Sashin Creek drainages near the southern end of Baranof Island provide additional useful information for the placement of the melt curve at lower elevations. Mean runoff from both basins is quite similar, 291 in. (7391 mm) for Deer Lake and 284 in. (7214 mm) for Sashin Creek. The mean elevation of Deer Lake is 1,300 ft (396 m) with a small area above 3,000 ft (914 m) while Sashin Creek's mean elevation is 1,130 ft (344 m) with the highest elevations just barely 2,000 ft (610 m). The runoff values based upon analyses in other areas of large mean annual precipitation in the study area suggest that a portion of each basin must have MAP values above 300 in. (7620 mm). Deer Lake has a tiny snow-covered or glaciated area between about 2,500 to 3,000 ft (762 to 914 m). Sashin Creek has no perennial snow cover. The compositing of these data provides good evidence of the excessive MAP necessary to allow enough snow cover below 3,000 ft (914 m) to last through the long melt season at such elevations.

The "no-snow" Sashin Lake and the "snow" Deer Lake data are shown on figure 11 as data that help define the curve at lower elevations. No other lower-elevation areas exist with values of MAP high enough to provide additional data input for the lower elevations. That is, unusually large MAP amounts are needed for elevations as low as 2,500 ft (762 m) to reach near glacial conditions because of the shortened accumulation season and, consequently, long melt season.

The tentative melt curve (based upon the data shown) is drawn considering both the "snow" and "no-snow" means. However, preference is given the "snow" or balanced data. This is particularly true for the composite of Baranof River, Takatz Creek, and adjoining data. For the upper portion of the curve, too much weight to the "no-snow" data would result in a rapid dropoff of melt with elevation. That is, smooth extrapolation beyond the snow and no-snow mean would result in an elevation of no melt that would be unrealistically low in relation to prevailing free-air temperatures.

2.4.2.5 Theoretical Low-Elevation Melt Curve Fix. A degree-day ($\geq 32^\circ\text{F}$ or 0°C) melt factor* of 0.05 per day was adopted for use at low elevations in southeast Alaska to help position the "potential" melt curve at low elevations. The main basis for the adoption of a factor of 0.05 was the mean estimated May 15 to June 15 reduction in snowpack water equivalent at the 1,000 ft (305 m) upper Long Lake drainage. The mean reduction in water equivalent was 23.7 in. (602 mm) with a range from 17 to 33 in. (432 to 838 mm). Using an average 1,000-ft (305-m) free air temperature of 50.5°F (10.3°C) for the May 15 to June 15 melt period with the mean 23.7 in. (602 mm) melt gives a degree-day melt factor of a little over 0.04). Since some other individual computations indicated somewhat higher factors, a 0.05 melt factor was adopted.**

Using the adopted 0.05 degree-day factor with degree days above 32°F (0°C) from the data at the 950-mb level of table 4 results in successive melt amounts shown plotted at the 950-mb level (approximately 1600 ft.) on figure 11. The total computed theoretical melt for the season is 154 in. (3912 mm). This value phases in quite well with the other data of figure 11 to help establish the melt curve.

2.4.2.6 Alternate Determination of Shape and Magnitude of Melt Curve From Temperature, Streamflow, and Snow Course Data. Temperature, streamflow, and snow course data can give guidance to the shaping and/or magnitude of both the total seasonal melt curve or to portions of it.

The temperature data (fig. 7) were used in combination with clues from streamflow and snow course data. The sloping dashed lines on figure 12 come from this combined use of data. The shaping placement of these curves involve both data and the following assumptions or working hypotheses.

- a. The decreasing length of melt season with elevation means that a curve placed on this figure to represent the beginning or ending of a month must slope toward the left side of the figure with increasing elevation. This has to be true since, with the prevailing decrease in temperature with elevation, the melt season starts later and ends earlier (the

*On an empirical basis the degree-day melt factor is defined as the melt in inches per day divided by the total degree days above 32°F (0°C) for the melt period.

**Personal communication (Anderson 1977) suggests the melt factor in Alaska should be less than the 0.08 characteristic of the mainland United States.

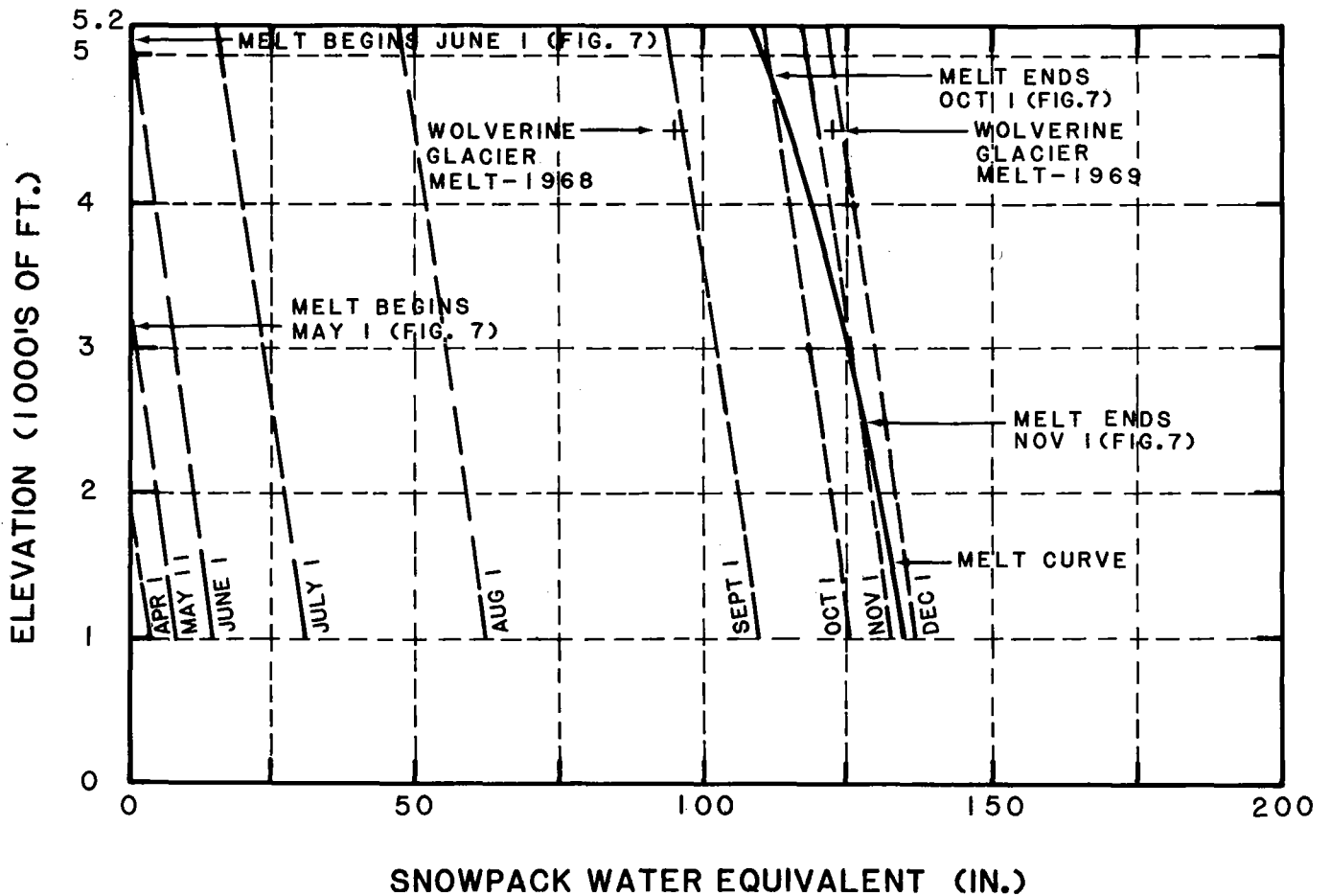

Figure 12.--Alternate estimate of melt curve with supporting data.

length of the season is shorter) as elevation increases.

- b. For the placement of these dashed sloping lines (i.e., the relative magnitude of one month's melt to the adjoining months) the following must be noted:
 1. Streamflow from selected basins, particularly if just partially glaciated, can provide some good clues for a melt reasonably early in the season. For such basins, the loss of contributing areas of the basin as the melt season progresses, however, decreases the usefulness of streamflow data for estimating melt beyond the first month or two of the melt season, unless some reliable estimate of contributing portion can be made.

2. If the extent of glaciation on a drainage is very large, the usefulness of such basins for melt estimates is also hindered, in this case, due to the thickness of the snowpack making the relation of runoff to melt less exact (e.g., storage, pondage, etc., become problems). In particular, early season melt estimates for such basins are on the low side. For extensively glaciated basins, the later season melt prior to loss of contributing area is the most useful.

Some assumptions and adjustments must be made in the use of stream flow to estimate the total month-by-month melt throughout the season because of the difficulty mentioned in b. above. These assumptions and/or adjustment techniques are:

- a. An assumption of approximate asymmetry of seasonal snowmelt is used. That is, the runoff and other data providing a placement of the monthly melt curves prior to July (since beyond June decreased contributing area for nearly all basins reduces their usefulness), we assumed beyond August (see sect. 2.4.2.6.2) the monthly magnitude of melt will be approximately a "mirror image" of the melt prior to July. For example, September is assigned the same (or approximately the same) melt as May, October the same as April, etc.

Theoretical computations of melt tend to support this approximate symmetry assumption of melt. See for example, the spacing of the theoretical melt points shown in figure 11.

- b. For the range of elevations with which we are concerned, a month's melt is assumed constant with elevation. This simplifying assumption is tied to the fact that we use data such as streamflow which, in most cases, is an integration of melt across several thousand feet variation in elevation. If we needed to extend our relations above 5,000 ft (1,524 m) the trend of the monthly melt must be such that melt becomes zero at some elevation well above 5,000 ft (1,524 m).

2.4.2.6.1 Spacing of April, May, and June melt curves. The dashed lines of figure 12 give monthly increments of melt. An anchor for spacing the dashed monthly melt lines on figure 12 was the estimated melt for the month of June. There are several reasons why June melt makes a good anchor providing one chooses appropriate basins for estimating melt. June is late enough in the melt season for the higher elevations in the chosen basins to be producing melt. Yet, it is not so late that the lowest elevations have already ceased contributing melt due to loss of snowpack.

One method for estimating monthly snowmelt involved individual yearly estimates. This was done for five common years of record, i.e., 1960-61 through 1964-65 for five basins. The method uses an index station for low-elevation rainfall. The ratio of basin runoff for the season to the index station's precipitation for the same period relates basin runoff to the index station's precipitation. Then, the month-by-month runoff is compared to the rainfall according to this relation. Subtraction of the estimated basin precipitation (that comes from the ratio method) from the basin runoff gives, if negative, the storage and, if positive, the snowmelt contribution runoff. Table 8 shows the estimated monthly snowmelt determined from this procedure for four nonglaciaded basins and one partially glaciaded basin, the Baranof River drainage.

Table 8.—Mean estimated monthly snowmelt runoff in inches (mm) by basins for five seasons, 1960-61 through 1964-65

Basin	Average basin elevation	Month											
		April		May		June		July		August		September	
		in.	mm	in.	mm	in.	mm	in.	mm	in.	mm	in.	mm
Perserverance Creek	1340	1.7	43	5.3	135	5.1	130	1.5	38	--	--	--	--
Fish Creek nr. Ketchikan	1800	1.3	33	4.2	107	10.8	274	3.8	97	--	--	--	--
Manzanita Creek	1300	2.6	66	5.8	147	9.1	231	5.5	140	--	--	--	--
Winstanley Creek	1730	0.6	15	4.1	104	9.3	236	4.8	122	--	--	--	--
Baranof River	2000	0.9	23	7.0	178	16.1	409	14.2	361	4.2	107	1.3	33

The slightly glaciaded Baranof River drainage is especially important for estimating June snowmelt, because the problem of contributing area is of less concern than with the other basins used. Yet, the Baranof basin is not so extremely glaciaded for other glacier related problems to be introduced. Table 8 shows the mean estimated snowmelt (in inches of water equivalent for the 5-year period for the Baranof River Drainage) for June of 16.1 in. (409 mm).

An alternate less time-consuming method for estimating snowmelt was tested using Baranof River data. This involved runoff data as shown for the Baranof River, table 9. The 12-yr period summarized includes the same five years used in the other method of estimating snowmelt.

In order to estimate snowmelt by the alternate method, the mean June runoff shown for Baranof in table 9 needs to be adjusted for the rainfall contribution. For this, we use the average June contribution to annual precipitation from table 6. The June precipitation is 4.28 percent of the MAP. For application of this percent, we take a MAP value of 206 in. (5232 mm) for the Baranof River drainage from our MAP analysis (fig. 6). The 4.28 percent times 206 in. (5232 mm) gives 8.8 in. (224 mm). Based upon the 1960-65 mean June Baranof runoff of 27.26 in. (692 mm), the subtraction of the estimated basin rainfall of 8.8 in. (224 mm) leaves an estimated snowmelt runoff of 18.5 in. (470 mm). Considering the differences in the two methods and the different assumptions in each, this 18.5 in. (470 mm) compares quite favorably with 16.1 in. (409 mm) of estimated snowmelt from the first method (table 8). Using

the 12-yr period (same 5-yr period as in table 9 plus available data since 1965), again the 8.8 in. (224 mm) subtracted from the longer record (12-yr) mean June runoff of 26.6 in. (676 mm) leaves 17.8 in. (452 mm) as the estimated mean June snowmelt contribution of runoff.

Table 9.—June runoff for the Baranof River

Year	Runoff	
	in.	mm
1961	33.15	842
1962	27.86	708
1963	17.33	440
1964	34.12	867
1965	23.82	605
Mean 1961-65	<u>27.26</u>	692
1966	23.80	605
1967	29.25	743
1969	33.62	854
1970	21.65	550
1971	27.61	692
1972	22.85	580
1973	24.19	614
Mean 1961-73 (1968 missing)	26.62	676

Since the less time-consuming second method applied to the Baranof River data compared quite favorably with the more time-consuming method, the second method was applied to additional more glaciated basins for estimates of June snowmelt. The results are summarized in table 10.

Table 10.—June snowmelt estimate for various partially glaciated basins

Basin	Mean June runoff		Period of record used	Estimated generalized MAP		Estimated rain portion of runoff		Estimated mean June snowmelt	
	in.	mm		in.	mm	in.	mm	in.	mm
Mendenhall R.	23.59	599	1966-74	175	4445	7.49	190	16.4	409
Lemon C.	25.33	643	1961-73	150	3810	6.42	163	18.9	480
Herbert R.	20.75	527	1967-72	155	3937	6.63	168	14.1	358

From the estimated melt for the month of June by the two methods for Baranof River and by the one method as summarized in table 10 for the other three drainages, an adopted average June snowmelt of 0.5 in. (12.7 mm) per day or 15 in. (381 mm) for the month appears to be a realistic amount. The symmetry assumption (see 2.4.2.6), is used to apply approximately 15 in. (381 mm) to September. Computations of estimated melt for Mendenhall Basin for September (not all of this basin is glaciated), discussed in section 2.4.2.6.2, (table 11) resulted in 12.8 in. (325 mm). Considering that about 0.8 of the Mendenhall

River basin is glaciated*, the estimated 16.0 in. (406 mm) is in good agreement with the symmetry assumption of about 15 in. (381 mm).

Table 11.—Estimated snowmelt runoff for Mendenhall River drainage

Month	Mean runoff		Estimated basin precipitation		Estimated snowmelt runoff	
	in.	mm	in.	mm	in.	mm
May	6.27	159	9.61	244	--	--
June	23.59	599	7.49	190	16.10	409
July	37.81	960	9.94	252	27.8°	708
August	47.89	1216	12.95	329	34.94°°	887
September	32.44	824	19.65	499	12.79	325
October	15.21	386	26.76	680	--	--

°Adjusts to 34.8 in. (884 mm). See text.

°°Adjusts to 43.7 in. (1110 mm). See text.

With an adopted 0.5 in. (12.7 mm) per day for June snowmelt, the placement of the dashed monthly melt curves on figure 12 comes from the following sequence of steps:

- a. Based upon figure 7, at an elevation of 5,200 ft (1,585 m) melt will begin on June 1.
- b. From figure 7, May 1 melt begins (with no earlier melt) at about 3,100 ft (945 m).
- c. May melt from partially glaciated basins is estimated as approximately 0.5 of June's melt**. Therefore, May's melt is assumed to be 7.5 in. (190 mm).
- d. From previous working assumption (for elevation span of concern) we use constant monthly increments.
- e. The May melt, 7.5 in. (190 mm), is scaled off at 3,100 ft (945 m). This now gives a point through which the June 1 dashed line can be extended from its intersection point with the ordinate at 5,200 ft (1,585 m). The line is drawn and extended to 1,000 ft (305 m).
- g. A parallelling line, scaled off to the 15 in. (381 mm) June melt, is extended to 1,000 ft (305 m) for the May melt curve.

*That is, perhaps nearly 0.2 of basin does not contribute in September. Assuming 0.2 applied for the noncontributing portion in September, the estimated melt (if 100 percent of basin were contributing) would be about 16 in. (406 mm), that is, 12.8 divided by 0.8.

**Table 8 shows Baranof River about 42 percent, but consideration of additional basins suggests about 50 percent.

2.4.2.6.2 Spacing of melt curves for July, August, and subsequent months.

Estimated snowmelt from the Mendenhall River drainage (fig. 4) plus comparisons with other basins form the basis for estimating the July and August melt. A summary of the estimated mean monthly (8 years of data) snowmelt runoff with supporting data for the Mendenhall River drainage is given in table 11.

The estimated basin precipitation (table 11) comes from the generalized MAP (fig. 4) and mean monthly percents of MAP from table 6. These values are: MAP - 175 in. (4445 mm); mean monthly percents of 5.49 for May, 4.28 for June, 5.68 for July, 7.40 for August, 11.23 for September, and 15.29 for October. Using these values, an estimated snowmelt runoff for each month was determined. These results indicate a net storage in May and October. Thus, for practical purposes the snowmelt season is June through September. The unadjusted July and August computed values of 27.87 in. (708 mm) and 34.94 in. (887 mm), respectively, were increased by 25 percent. This comes about through estimating that with the basin approximately 0.8 glacier covered, there is 0.2 basin that likely is non-contributing in July and August. Therefore, dividing the 27.87 in. (708 mm) for July and the 34.94 (887 mm) for August by 0.8 gives the 34.8 in. (884 mm) for July and 43.7 in. (1110 mm) for August. This combined July, August total of approximately 78.5 in. (1994 mm) is reapportioned for convenience on the basis of an even 1 in. (25.4 mm) per day for July and 1.5 in. (38.1 mm) per day in August giving a July plus August total melt of 77.5 in. (1968 mm). These are thus estimated melt amounts if 100 percent of the basin were contributing melt rather than 80 percent.

For months following August, the symmetry assumption discussed under section 2.4.2.6 is used. Thus, for September ("symmetry month" for June), we adopt 0.5 in. (12.7 mm) per day; for October (May's symmetry month) 0.25 in. (6.35 mm) per day; for November (April's symmetry month) 0.125 in. (3.18 mm) per day.

2.4.2.6.3 Suggested shape and magnitude of melt curve from composite of empirical data.

With adopted values of monthly melt through the season and slope of the melt curves determined, one factor remains for firming a melt curve by this alternate method. This factor concerns dates of ending of melt with elevation. According to figure 7, November melt prevails up to 2,500 ft (762 m) and October melt extends to about 4,900 ft (1,494 m). From results of all the data discussed in this section we define a melt curve independent of the melt curve discussed in sections 2.4.2.4 and 2.4.2.5. This independently determined melt curve is shown on figure 12 with supporting data.

2.4.2.7. Snow Course Data as a Check. Since prevailing temperatures near the south coast of Alaska during the melt season are quite similar to our study area, we can use snow course data from Wolverine Glacier (2-yr record) at an elevation of 4,430 ft (1,350 m) as a rough check on placement of the melt curve. Long-duration melt data were available for both 1968 and 1969 at the 4,430-ft (1,350 m) site.

In June 1968, a 184 in. (4674-mm) snow pack had 95.7 in. (2431 mm) of water equivalent. By September 15, this had reduced to 41 in. (1041 mm) of snow or 21.3 in. (541 mm) of water equivalent, giving a total reduction in water equivalent of 74.4 in. (1890 mm). On June 3, 1969, a 207-in. (5258-mm) snow cover with a water equivalent of 107.1 in. (2720 mm) reduced to 5.9 in. (150 mm) by September 14. These values are plotted on figure 12 after adding 20 in. (508 mm) for expected melt prior to June at the 4,430-ft (1,350-m) elevation.

The adopted melt curve on this figure fits in the range of this independent data quite well.

2.4.2.8. Adopted Melt Curve. Two separate methods of estimating a melt curve have been discussed. The estimated melt curve from one method (sec. 2.4.2.4 and 2.4.2.5) is shown on figure 11, the other (section 2.4.2.6), on figure 12. Figure 13 shows the adopted melt curve transformed so that MAP is the abscissa and elevation is the ordinate. An area, rather than a line, is used to separate melt from glaciation.

2.4.3 Use of Melt Curve for Adjustments to First Approximation Mean Annual Precipitation Chart

In the beginning of section 2.4 we introduced the concept of using small snowfields or glaciers for adjusting the first approximation MAP map. We pointed out the need for a relation of MAP to accumulated snowpack with elevation and a relation which tells us how much melt to expect in a season at a given elevation.

The solution of the first required relation shown in figure 8 is combined with a mean estimated melt curve to give us the combined relation in figure 13. This combination of derived relations was then used in accordance with the purpose set forth in section 2.4.2.1. To accomplish the purpose of adjusting MAP, both the existence and nonexistence of small glaciers or snowfields were thus used (as determined from U.S. Geological Survey topographic charts) to check and adjust the tentative MAP chart. Acceptance of the melt curve of figure 13 represents a "balanced" condition indicating no significant increase or decrease in snow cover. That is, the accumulated snowpack just completely melts during the warm months just as the time is reached for a new seasonal snowpack to begin accumulating.

In the area above the melt curve on figure 13, excess snowpack accumulates providing glaciation, while below the curve, all the cold season accumulated snowpack melts. On figure 13, a zone around the melt curve (sec. 2.4.2.8) is indicated representing a span of MAP of ± 12.5 in. (± 318 mm) to allow for a margin of uncertainty in placement of the line of demarcation or melt curve. Thus, in practical application, unless a change in the first approximation MAP analysis of 12.5 in. (318 mm) or more is indicated in a particular area, no adjustment is made.

Thus, the use of figure 13 is based on the information provided by the melt curve and where this melt curve, with a MAP span of 25 in. (635 mm) for various elevations, is intersected by various MAP lines. For example, the melt curve is intersected by the 200-in. (5080-mm) MAP line at about 4,000 ft (1,220 m) or a little higher. Thus, if an area near or slightly above 4,000 ft (1,220 m) has small glaciated areas, one should assume that the MAP in such an area ought to be close to 200 in. (5080 mm). If the first approximation analysis based on the closest data caused us to place only 150 in. (3810 mm) in such an area, from the use of figure 13, we conclude the amount ought to be increased about one-third. In addition to the type of check just described, figure 13 was also used to check against "overdoing" the amount of MAP.

The existence, or nonexistence, of small glaciated areas over various portions of our study area was evaluated in the light of figure 13 for suggested changes in the first approximation MAP chart. A representative sampling of the main adjustments made using figure 13 are:

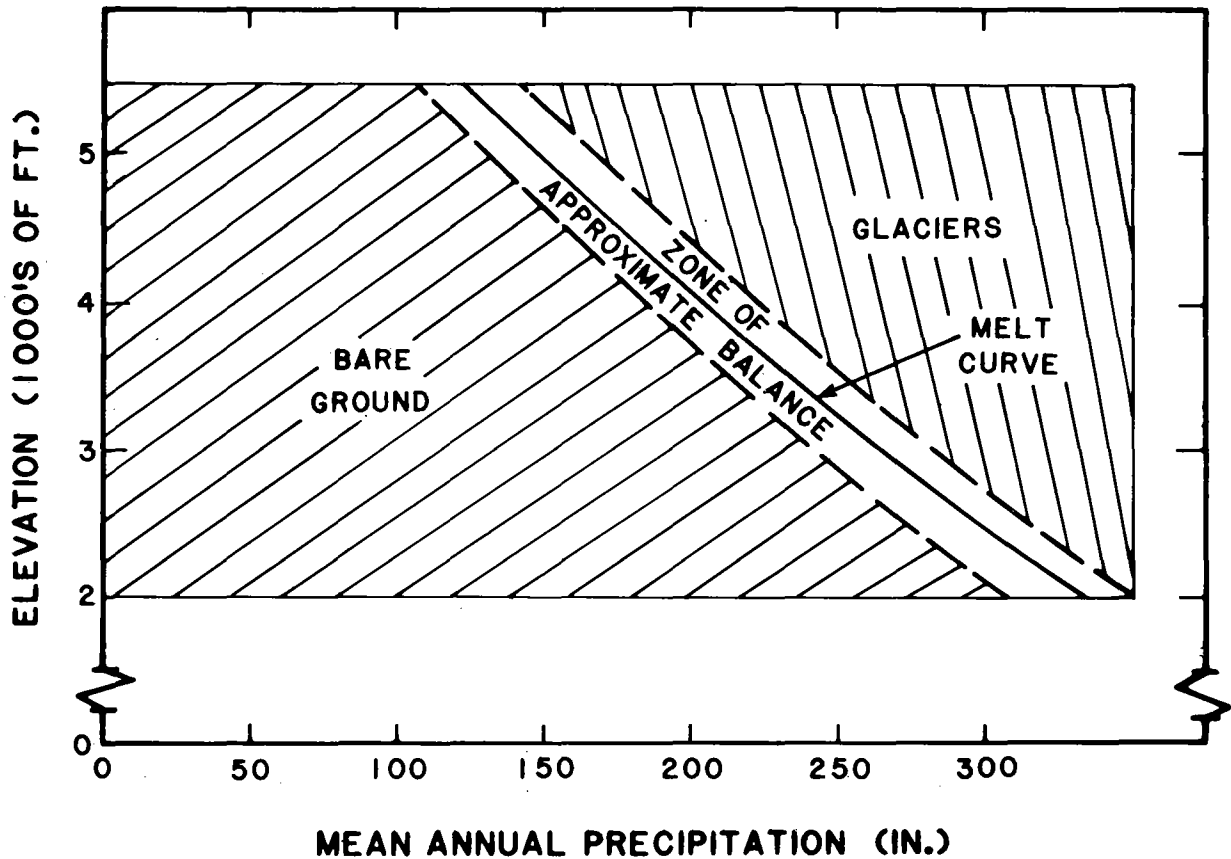

Figure 13.—Melt curve vs. mean annual precipitation and elevation for adjustments to first approximation mean annual precipitation chart.

- a. North of the area of balanced analysis of figure 10 on Baranof Island, small glaciated areas exist near and somewhat below 4,000 ft (1,220 m). There are no basin runoff values in these areas suggesting what the MAP ought to be. Based upon figure 13 though, we have extended a 200 in. (5080 mm) MAP area to cover these small "balanced" snow-covered areas. We do not go as high as 250 in. (6350 mm) in this area, however, since values this high would likely contribute to more extensive glaciation than now exists.
- b. Examination of the topography of basins such as the Harding River, the Klahini River, and Cascade Creek jointly indicate elevations of 4,000 ft (1,220 m) or a little higher are needed for the formation of snowfields or small glaciers. A generalized MAP of about 175 in. (4445 mm) appeared adequate for explaining the small glaciated areas that exist near the higher elevations. This analysis permits the existence of some higher MAP in some portions of this

area. The highest generalized value of 175 in. (4445 mm) allows for the sizeable areas well below 4,000 ft (1,220 m) that cover much of this region.

The generalized highest isohyetal value of 175 in. (4445 mm), determined from the aforementioned basins, was applied throughout the region of similar overall topography both between and beyond these basins.

- c. The region around Juneau is one of rather dense data coverage (low-elevation rain gages plus considerable streamflow measurements). However, this is also a region of pronounced changes in orography in rather small distances. Small areas in and around Carlson Creek and Gold Creek are snow-covered or glaciated even though the highest elevations are barely 4,000 ft (1,220 m) or slightly higher. This suggests (by fig. 13) a MAP of 200 in. (5080 mm) or higher for these areas. The generalized MAP lines over these and adjoining basins are drawn so that we allow for two other factors. These are: (1) the low-elevation precipitation measurements nearby and (2) the fact that portions of Carlson Creek, Gold Creek, and nearby basins are below 1,000 ft (305 m). A generalized MAP isoline must be representative of the average elevation that it encompasses (sec. 2.2.1).
- d. An area void of conventional precipitation and also runoff data is the area around the Chilkat range -- the main close-in barrier to the west of the Juneau area. Here, on the basis of figure 13, we build up the MAP to a generalized value of 175 in. (4445 mm). Elevations of 4,000 ft (1,220 m) or a little higher are generally required for limited glaciation in this region. Occasionally, small glaciers appear at elevations below 4,000 ft (1,220 m). However, we judge a rather sizeable 175-in. (4445-mm) isohyet adequate for this mountain range since it encompasses quite a large area that goes below 1,000 ft (305 m).
- e. On Admiralty Island (near 57.75°N, 134.50°W), a small 150-in (3810-mm) isohyet is inserted to make some allowance for isolated areas of near 200 in. (5080 mm) to account for the small glaciers around 4,000 ft (1,220 m) in this area. The predominance of elevations below 2,000 to 3,000 ft (610 to 915 m) suggests not going any higher than this on a generalized basis.

The five examples just discussed demonstrate how figure 13 was effective in adjusting the first approximation MAP chart on the basis of existence or nonexistence of small glaciers. Although the development of the procedure was

rather involved and challenging, reward came in its utility for improving the MAP analysis in mountainous areas that had insufficient alternate data.

2.5 Final Mean Annual Precipitation Chart

Figure 4 shows the final MAP analysis based upon a first approximation from precipitation measurements, streamflow measurements, and generalized topographic considerations and with further adjustments for existence or nonexistence of small glaciers. This MAP chart becomes a key input to development of generalized 24-hr 10-mi² PMP (26 km²) described in chapter 3. Somewhat more detailed orographic considerations are part of the PMP development.

3. PROBABLE MAXIMUM PRECIPITATION FOR SOUTHEAST ALASKA

3.1 Introduction

A generalized study and numerous individual basin estimates of probable maximum precipitation (PMP) have been made for Alaska (sec. 1.1). These estimates have involved a variety of approaches. Frequently, analogies were made in the earlier studies to similar regions in western United States for guidance in maintaining the same general level of PMP in both regions. The analogies were required since the observational network in Alaska is very sparse. Large regions may have only a few stations, and some rather extensive regions lack any data. Even where observations are available, they frequently are not representative of the diverse physiographic regions of Alaska.

PMP estimates made on a generalized basis, that is, mapped values over a region, avoid inconsistencies that could easily result from estimates made at various times for individual basins. The available Alaskan generalized PMP report (Miller, 1963) is for the entire State. In this 1963 generalized study, the relation of PMP to orography came from relations developed for mountains in the western states from California northward.

The present generalized PMP study concentrates on just the southeast portion of Alaska (fig. 1) with a primary aim of providing a greater definition of orographic effects for the restricted area of concern than that provided by the earlier generalized study that covered all of Alaska. Seasonal variation to cover the snowmelt season is also included. Using the MAP chart (fig. 6) for southeast Alaska described in chapter 2 as an index, we developed relations of PMP to MAP from portions of a generalized PMP report for the Northwest States (U.S. Weather Bureau, 1966). We also made use of another technique where 100-yr rainfall values in southeast Alaska were related to MAP and PMP.

Three factors that influenced the approach used in developing generalized estimates for southeast Alaska are:

- a. The varied and complicated orographic features of the region,
- b. The fact that nearly all the regular precipitation measurements are at low elevations, and
- c. The short record length of most precipitation stations and consequently the lack of a large number of stations with long continuous records.

We know from many studies of major storms and PMP in other orographically complicated areas that the orography in southeast Alaska must produce significant effects on precipitation. After reviewing the topography and storm morphology in the western United States, we chose the western portion of the State of Washington as the most appropriate region for development of relations between PMP and MAP that could then be adapted for use in southeast Alaska. Except for points in the Olympic Mountains region* (where orographic effects on precipitation are somewhat more severe than the most orographic portion of the study area), western Washington has many orographic features similar to southeast Alaska. Additionally, large precipitation amounts result from similar storm types.

3.2 Relation Between Probable Maximum Precipitation and Mean Annual Precipitation

3.2.1 Relation from Western Washington

Figure 14 shows the location of points in western Washington for which 24-hr 10-mi² (26-km²) PMP was determined from Hydrometeorological Report No. 43 (U.S. Weather Bureau, 1966). MAP was determined from an analysis prepared by the National Weather Service River Forecast Center, Portland, Oregon (1965). A plot of these data and a fitted linear regression line are shown in figure 15. The linear relation has a correlation coefficient of 0.87 and standard error of estimate of 3.5 in. (90 mm).

3.2.2 Adjustment of Western Washington Relation for Use in Southeast Alaska

Storm morphology is basically the same for the region from western Washington to southeast Alaska. Substantial influx of moisture with rather strong pressure patterns characterize most storms affecting the region. As latitude increases, the average interval between storms decreases. Also, the number of months during which the same basic rain-producing storm type prevails increases as the latitude increases. Both of these effects result in greater MAP with increasing latitude, other things, such as orographic effects, being the same. This does not mean that PMP should necessarily increase with increasing latitude. In other words, for large areas with varying topography, large MAP values with increasing latitude does not, in itself, imply larger PMP.

In addition to the influence of terrain and varying storm frequency, the optimum interplay of storm efficiency and moisture determine the magnitude of PMP. Ideally, one might try to develop a family of relations of PMP versus MAP for a variety of orographic settings each with a similar storm morphology and adjust these for storm frequency. Unfortunately, the requisite information is not available. Therefore, we developed a single relation of MAP versus PMP for western Washington, fully realizing that some of the area (i.e., Olympic Mountain upslopes) has the capability of experiencing greater PMP than the less extensive upslopes of southeast Alaska.

We adjusted the relation based on Washington data for the effect of greater storm frequency on MAP with increasing latitude. We developed the storm-frequency adjustment from the data in "Principal Tracks and Mean Frequencies of

*Numbers 18-33 in figure 14.

Cyclones and Anticyclones in the Northern Hemisphere" (Klein, 1957). We summed the annual frequency of storms in 5° lat.-long. quadrangles along the west coast of North America from California to southeast Alaska. Figure 16 shows the results of this summation expressed as a percent of the number of low centers off the Washington coast (quadrangle C). The 47 percent greater frequency of storms off southeast Alaska is used in adjusting the Washington relation of figure 15 for use in southeast Alaska, i.e., the regression curve is multiplied by the inverse of 147 percent.

The validity of using the frequency of low-pressure centers as an adjustment technique for equating MAP values along the coast rests upon the assumption that the average of individual storm precipitation intensities (as distinguished from orographic effects) does not vary much with latitude. In other words, it is the greater number of days with storms as latitude increases that makes the difference in buildup in MAP with latitude. The similarity of depth-duration precipitation summaries of storms along the west coast supports similar storm characteristics. Apparently what happens is that the somewhat higher winds with increasing latitude in storm situations are counteracted on the average by lessened moisture with latitude to make the average storm precipitation intensity (without orographic effects) about the same.

The validity of the use of this frequency-adjustment technique also required that the MAP curve comes predominantly from the same overall storm type. For example, if thunderstorms contributed if thunderstorms contributed significantly to the season's precipitation total for only a portion of the region for which such an adjustment is used, we would have to take this into consideration by some adjustment, or otherwise abandon such a technique. Since organized low-pressure systems predominate in most of the precipitation-producing situations along the west coast of North America north of California, we did not have to concern ourselves with this mixed-storm-type problem.

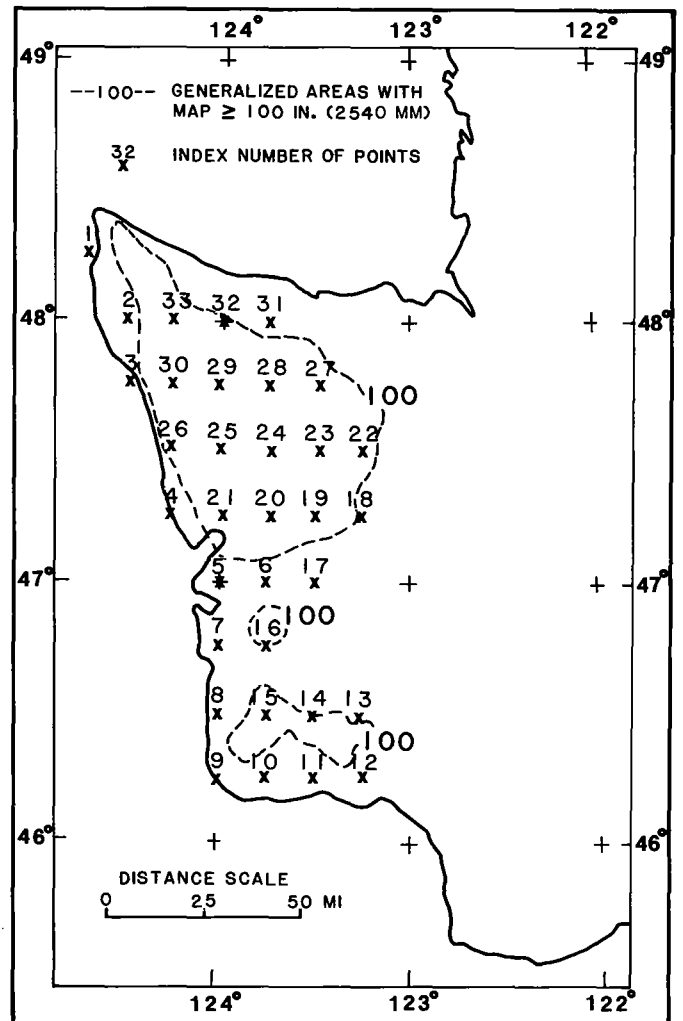

Figure 14.—Location of western Washington points used for probable maximum precipitation vs. mean annual precipitation relation.

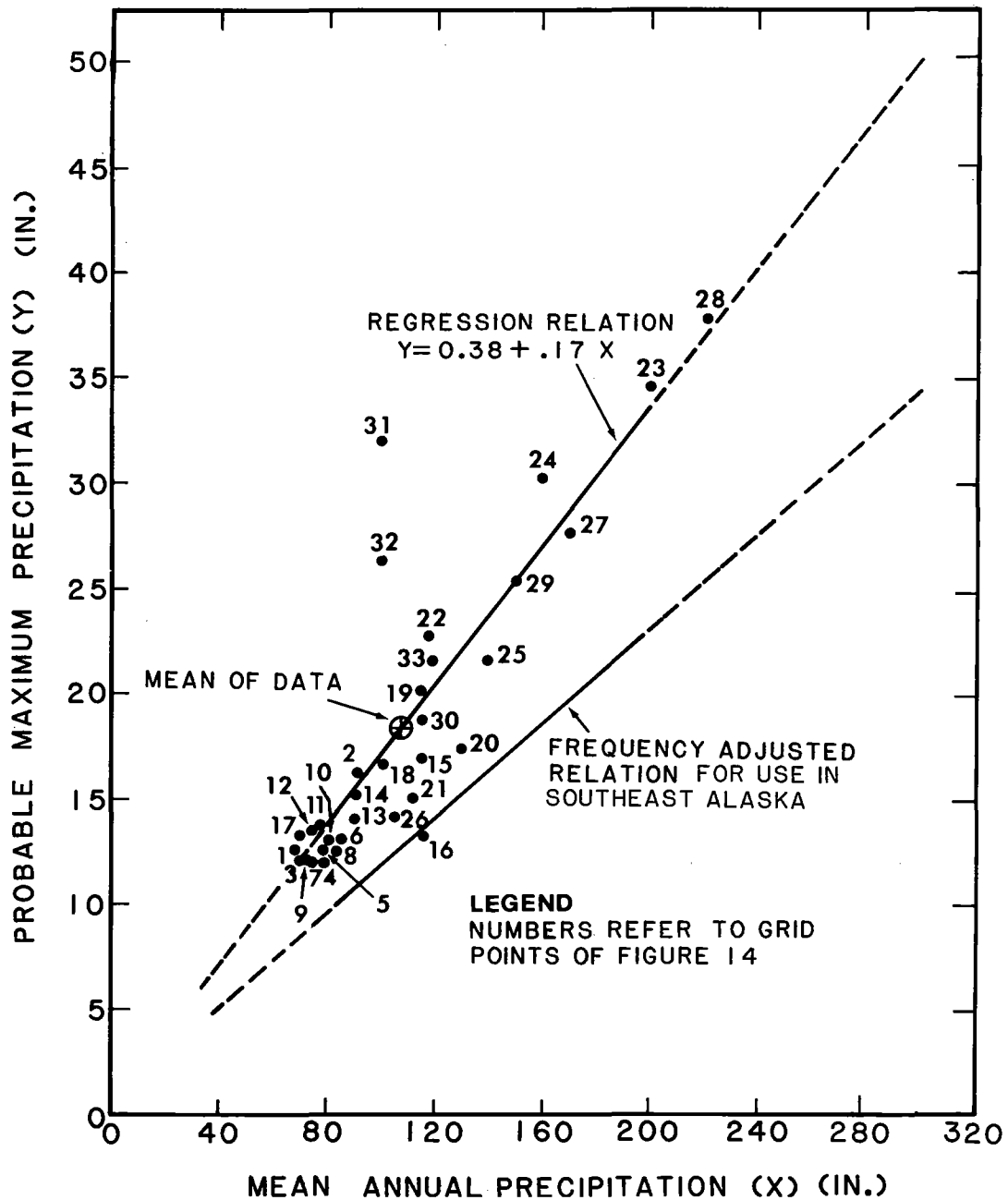

Figure 15.—24-hr 10-mi^2 probable maximum precipitation vs. mean annual precipitation from western Washington data.

3.3 Recurrence Interval Rainfall Values Versus Probable Maximum Precipitation Relations

3.3.1 Data and Unadjusted Relations

In this method of estimating MP, we developed a relation of 100-yr rainfall to MAP using data from southeast Alaska. For 15 stations well distributed geographically throughout southeast Alaska, 100-yr, 24-hr rainfall values were determined. Although it would have been desirable to use additional stations, the daily data for other stations had too many periods of missing or accumulated

data to permit reliable frequency determinations for the rarer recurrence intervals. The plot of the 100-yr, 24-hr rainfall values vs. MAP with a computed linear regression line is shown in figure 17 (identification numbers on station data points on the figure refer to table 12). The correlation coefficient is 0.72, and the standard error of estimate 1.9 in. (48 mm). A plot of maximum observed 24-hr precipitation amounts for 49 stations in southeast Alaska vs. MAP reinforced the relation shown in figure 17. These data are discussed in section 3.5.2.1.

3.3.2 Adjustment of Relation for Estimating Probable Maximum Precipitation

The linear relation from figure 17 "predicts" 100-yr, 24-hr rains from MAP. In order to predict PMP from MAP, the basic relation (fig. 17) needs to be transformed. This comes from application of a general relation between PMP to 100-yr ratios and MAP. Plots of PMP/100-yr ratios vs. MAP characteristically show considerable scatter. However, a definite characteristic trend prevails in that PMP/100-yr ratio increases with smaller values of MAP. This has been noticed in numerous PMP studies that embrace regions with a large range in MAP. The most recent of these studies covers the southwest United States (Hansen, et al. 1977).

Figure 8.10 in Hydrometeorological Report No. 36 (U.S. Weather Bureau, 1961) indicates that the lowest PMP/100-yr ratios (inverse of numbers shown on figure 8.10 in that report) in California may be below 2.0. A characteristic value for both coastal mountainous areas and the Sierra Nevada in California where MAP is large is about 2. For the areas on figure 8.10 of Hydrometeorological Report No. 36 encompassed by PMP/100-yr ratios of less than 2, an overall average MAP of about 45 in. (1143 mm) prevails. According to our frequency-adjusted curve of figure 16, this 45 in. (1143 mm) would be adjusted to a comparable southeast Alaska MAP of about 220 in. (5588 mm). In the more protected portions of the Sacramento and the San Joaquin Valleys, a PMP/100-yr ratio of around 2.5 is characteristic. Where the San Francisco Bay "opening" to moisture influx influences Sacramento Valley precipitation (more characteristic of the "broken-up" character of the Southeast Alaska terrain), a PMP/100-yr ratio of 2.2 is characteristic. The MAP of approximately 20 in. (508 mm) characteristic of this California 10 in. (254 mm) MAP characteristic of this California region adjusts for southeast Alaska by (fig. 16) to a comparable southeast Alaska value of about 50 in. (1270 mm).

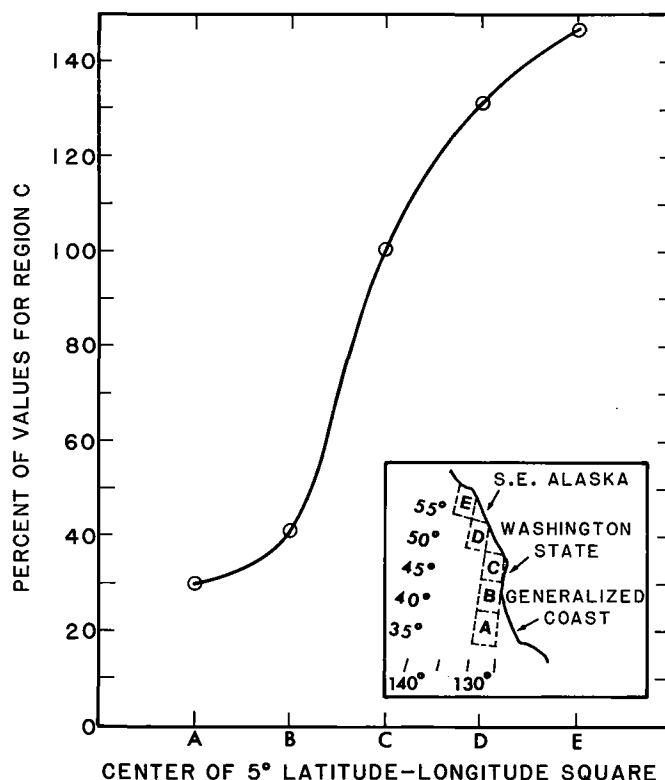

Figure 16.—Variation of frequency of lows with latitude offshore of west coast of North America.

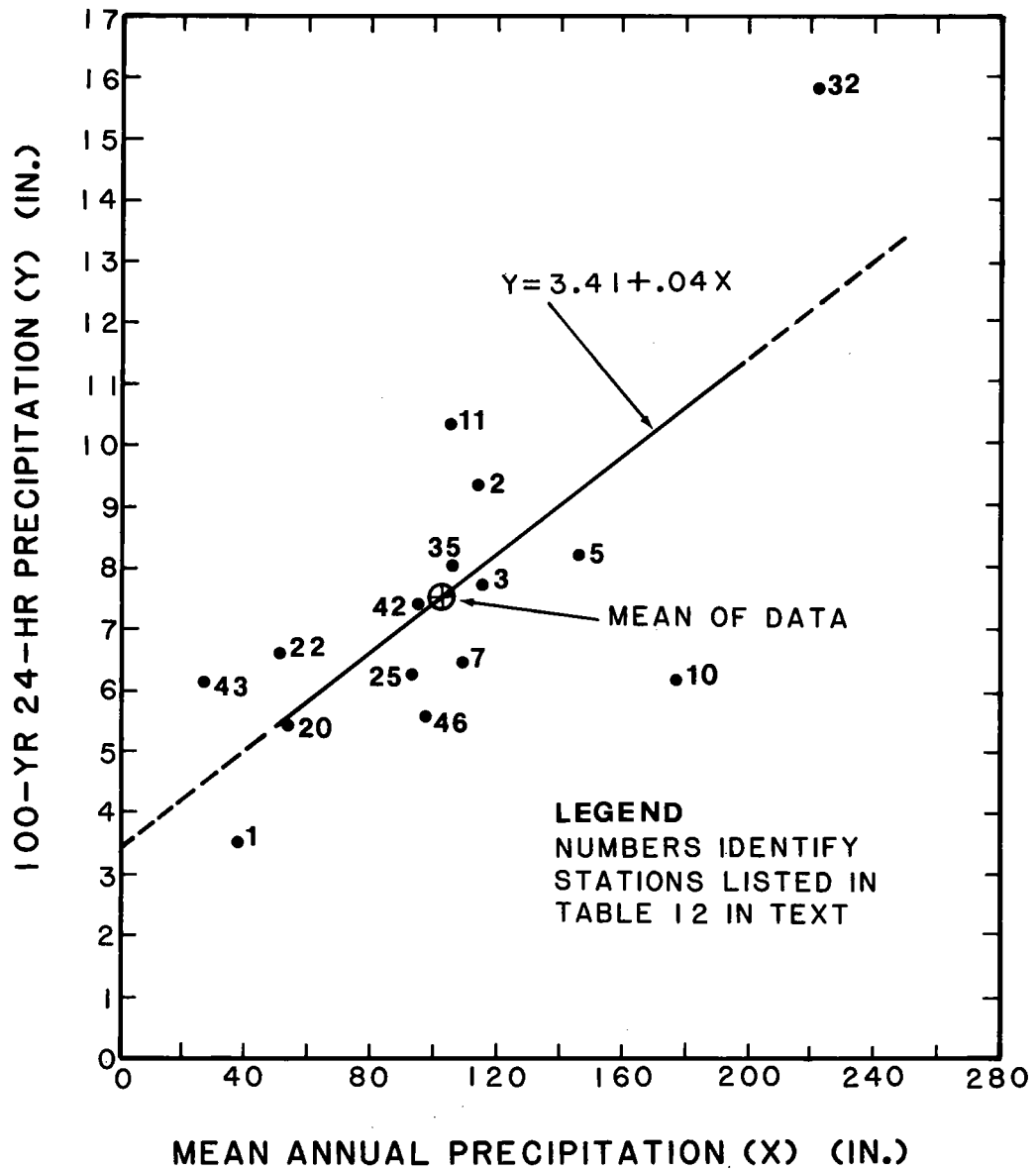

Figure 17.—100-yr, 24-hr precipitation vs. mean annual precipitation for southeast Alaska data.

We chose the low-lying area around but mostly west of Portland, Oregon to investigate the variation of PMP to 100-yr ratios for another area where the MAP ranges from 40 to 60 in. (1016 to 1524 mm). This low-lying area between the coast range and the Cascades most closely mimics upwind barrier effects for those areas of southeast Alaska where the MAP drops well below the coastal values. Based upon 14 grid points (with 1/4 degree spacing) within about 40 mi (64 km) of Portland, the mean PMP/100-yr ratio is 2.3 and the MAP is 50 in. (1270 mm). By use of the relation in figure 16, a MAP of 50 in. (1270 mm) at the latitude of Portland, Oregon, adjusts to about 90 in. (2286 mm) for southeast Alaska.

Table 12.—Stations used to develop recurrence interval versus probable maximum precipitation relations

Station Index No.	Station	Lat.		Long.		Elev. ft. m	Length of record yrs.	100-yr 24-hr precip.		Mean annual precip.
		(°)	(')	(°)	(')			in.	mm	in. mm
1	Angoon	57	30	134	35	35 11	29	3.53	90	38 965
2	Annette (R)	55	02	131	34	110 34	29	9.33	237	114 2896
3	Annex Creek	58	19	134	06	24 7	53	7.74	197	114 2896
5	Baranof	57	05	134	50	20 6	24	8.22	209	147 3734
7	Bell Island	55	55	131	35	10 3	21	6.47	164	109 2769
10	Cape Decision	56	00	134	08	39 12	27	6.15	156	77 1956
11	Cape Spencer	58	12	136	38	81 25	34	10.36	263	105 2667
20	Gustavus FAA	58	25	135	42	22 7	31	5.44	138	54 1372
22	Haines Terminal	59	16	135	27	175 53	13	6.64	169	52 1321
25	Juneau City	58	18	134	24	25 8	54	6.29	160	93 2362
32	Little Port Walter	56	23	134	39	14 4	34	15.83	402	222 5639
42	Sitka Magnetic	57	03	135	20	67 20	35	7.48	190	96 2438
43	Skagway	59	27	135	19	18 5	29	6.17	157	27 686
46	Treepoint Light Station	54	48	130	56	36 11	37	4.93	125	98 2489
48	Wrangell	56	28	132	23	37 11	50	5.59	142	80 2032

The PMP/100-yr ratio adopted for adjusting the basic figure 17 relation ranged from near 2.4 at a MAP of 50 in. (1270 mm), near 2.2 at a MAP of 100 in. (2540 mm), and near 1.8 at a MAP of 220 in. (5588 mm). The resulting transformed curve relating MAP to PMP (rather than 100-yr rain to PMP) is shown in figure 18. This transformed linear regression is the second method for making a first approximation to point PMP estimates.

3.4 Combination of the Methods for First Approximation Probable Maximum Precipitation

The (ratio-adjusted and frequency-adjusted) linear relations from the two methods of relating PMP to MAP are shown on figure 18. The adopted relation is also shown on this figure. Neither of the separate relations provides, by itself, acceptable results. A better solution is believed to be obtained by a combination of the two methods. We adopted the mean of the two linear relations for MAP values above 100 in. (2540 mm) but a nonlinear modified relation for

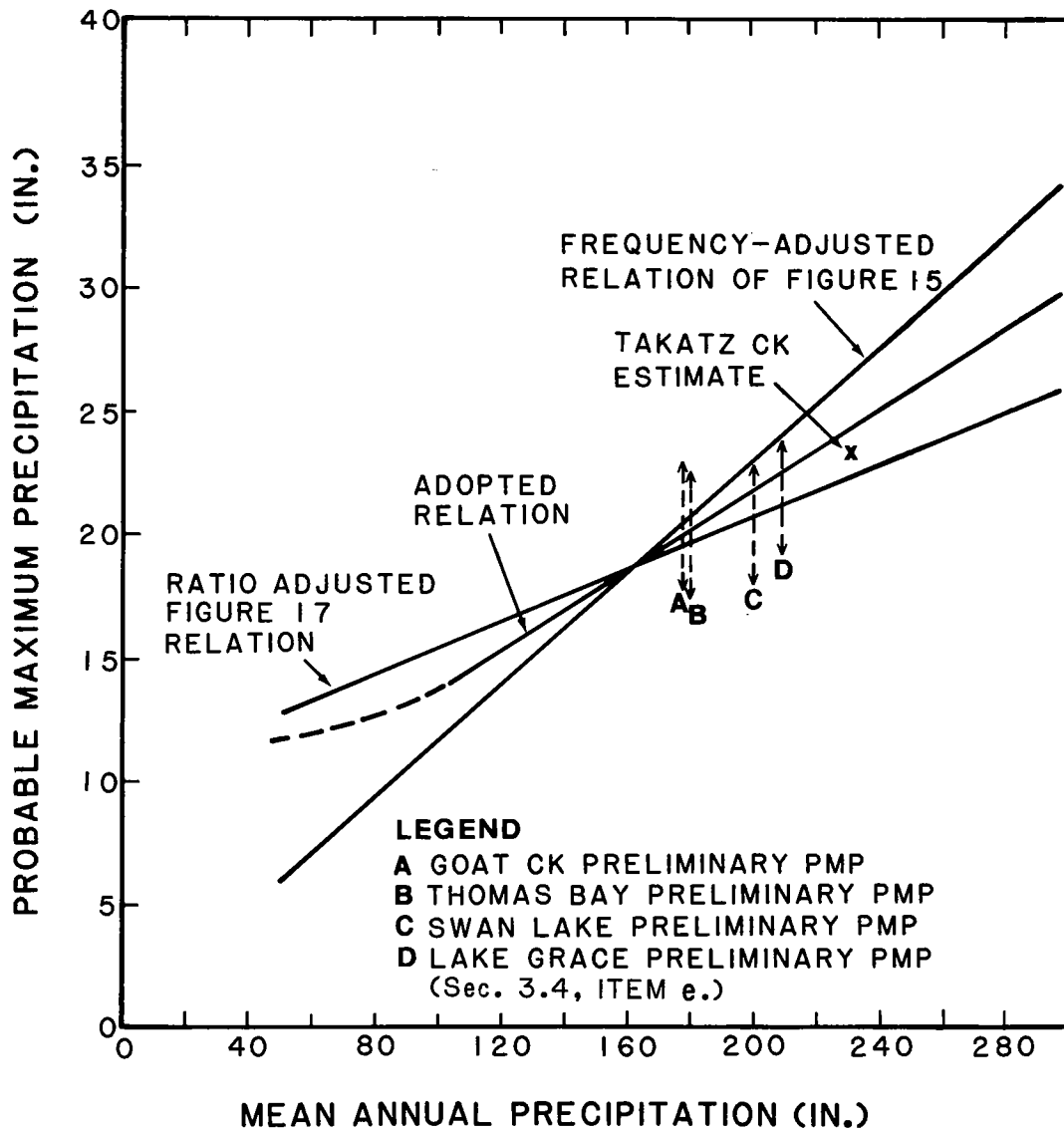

Figure 18.—Adjusted linear relations from figures 15 and 17, adopted linear relations and comparisons.

lesser MAP values. The dashed portion of the curve on figure 18 shows a variation in this adopted modification from linearity. The reasons for preferring a combination rather than the individual relations are:

- a. Extension of the Washington frequency-adjusted linear relation of figure 18 PMP to MAP (fig. 15) to low values of MAP suggests practically no PMP as MAP approaches zero. Extension of the same relation to a MAP of 300 in. (7620 mm) in southeast Alaska gives a 24-hr, 10-mi² (26-km²) PMP of well over 30 in. (762 mm) (see point c.)

- b. We considered a study of PMP in 1967 for the Takatz Creek drainage on Baranof Island as providing a valid general level of 24-hr 10-mi² (26-km²) PMP for the type of orography existing in that basin. This estimate involved orographic computations for the upslopes on Baranof Island. In addition, confirmation of the general level of total 24-hr PMP was provided by tie-ins with western United States estimates (U.S. Weather Bureau, 1961) by means of an earlier (1961) estimate for Bradley Lake, near the south coast of Alaska.
- c. We suggest that for the study area (except possibly the steep upslopes in the extreme northwest portion) just slightly over 30 in. (762 mm) in 24 hours should be the upper limit to PMP for the regions of the most extreme orographic effects. Parts of Baranof Island are somewhat more orographically affected than the Takatz Creek basin and should have larger PMP values than for the Takatz Creek drainage.

In the extreme northwest portion of the study area, there are areas near the coast where significant ground slopes extend up to 6,000 to 7,000 ft (1,800 to 2,100 m) or higher. Such conditions exist in the Olympic Mountains of Washington and for some areas in southern California where the 24-hr PMP exceeds 30 in. (762 mm). Since the extreme upslope conditions of the Olympic Mountains are duplicated only in the extreme northwest part of our Alaskan study area, we judge only in this limited region of our study area should we exceed the 30 in. (762 mm) value.

- d. Adoption of the Washington curve results in too drastic a departure from the adopted smooth trend in PMP/100-yr ratios as the MAP approaches 50 in. (1270 mm). For example, for a MAP of 50 in. (1270 mm), the 100-yr, 24-hr value from figure 17 is 5.21 in. (133 mm). The frequency-adjusted Washington relation (fig. 15) gives only slightly more than this resulting in a PMP/100-yr ratio only slightly over unity. At a MAP of 200 in. (5080 mm), the 100-yr 24-hr value from figure 17 is 11.21 in. (285 mm) while the frequency-adjusted Washington relation (fig. 15) gives about 23 in. (584 mm) for a ratio near 2. Thus, the departure from the suggested trend (using the frequency-adjusted Washington relation) is so great that the desired trend (higher PMP/100-yr ratios for smaller MAP) is actually reversed. Contrasted to this reversal, the adopted relation (see fig. 18) results in a PMP/100-yr ratio of 2.2 based on an 11.91-in. (302-mm) PMP for a MAP of 50 in. (1270 mm) and a ratio of 1.9 based upon a

21.8-in. (554-mm) PMP for a MAP of 200 inches (5080 mm). Thus, the adopted relation preserves an appropriate trend in PMP/100-yr ratios that allows for increases in the ratio as MAP lowers below 50 in. (1270 mm).

- e. Four recent Hydrometeorological Branch studies (A, B, C, and D on figure 18) giving ranges* in PMP values took into account differences in orographic features between each of these basins, respectively, with orography in and surrounding the Takatz Creek drainage. In addition to this relating the orography to that in and near Takatz Creek, several other techniques were used for estimating a range of PMP values for these basins. These techniques (used for obtaining a range in PMP values) involved:

1. Use of a tentative generalized rainfall-elevation relation.
2. Adjustment of a record September 1918, 3-day rainfall at Ketchikan.
3. Comparison with Technical Paper No. 47 values.
4. Use of a 24-hr, 10-mi² (26-km²) PMP to 100-yr, 24-hr point precipitation.

Not all of these techniques are completely independent of procedures developed for this generalized approach. However, there is sufficient independence in these estimates, to use the range in PMP values for judgment in reference to the general level resulting from the adopted generalized relation.

3.4.1 Additional Support for Combined Relation

The discussions in sections 3.4.1.1 and following provide additional support for the adopted nonlinear relation for MAP values less than 100 in. (2540 mm).

3.4.1.1 Use of Largest Probable Maximum Precipitation Amounts From the Contiguous United States. Using the contiguous United States as a much larger sampling region, we can consider the 24-hr PMP for such a region as a rough approximation to estimating nonorographic PMP for southeast Alaska. Use of the maximum Gulf of Mexico coast nonorographic PMP as a guide for southeast Alaska nonorographic PMP suggests that a linear extension of the adopted

* A range in PMP values was given in each of those estimates pending completion of this generalized study.

relation below a MAP of 100 in. (2540 mm) produces a PMP that is too low. This use of the coastal Gulf of Mexico value involved an adjustment for moisture and a storm mechanism adjustment. A dual adjustment is realistic as both relative moisture charge and relative differences in storm types and, thus, possibly storm efficiencies are important.

The basic contiguous U.S. PMP value used in this technique derives from a recent report of PMP for the Eastern United States (Schreiner and Riedel, 1978). Along the Gulf coast, the adopted 24-hr, 10-mi² (26-km²) amount is 47.1 in. (1196 mm). The primary storm support for this PMP value came from the slowly moving or slowly looping Hurricane Easy in September 1950 whose track was in the eastern Gulf of Mexico off the west coast of Florida. The storm produced an observed 24-hr, 10-mi² (26-km²) amount of 38.7 in. (983 mm) centered at Yankeetown, FL. In southeast Alaska, the midlatitude disturbance in the fall is the efficient precipitation producer. It is difficult to conceive of such a mid-latitude storm mechanism being as efficient in concentrating rainfall as the slowly moving or looping Hurricane Easy. However, experience indicates that it is difficult to quantify such differences in efficiency. Thus, just a "token" efficiency adjustment of -10 percent is added to the primary adjustment for moisture availability in the new location.

We have assumed a "token" efficiency adjustment of -10 percent, realizing insufficient knowledge exists to really quantify such a factor. However, we do believe the 10-percent figure may be conservatively low on the basis that no known occurrence of repeating "efficient" thunderstorms or stationary Low's has produced a 24-hr rainfall equal to that measured in the looping Yankeetown hurricane. It is important to remember that, in this comparison of storm efficiencies, we are concerned with the rainfall potential for a 24-hr duration. Other factors become important when dealing with significantly shorter or longer durations and different adjustments in efficiencies may be appropriate.

The moisture adjustment of the Gulf coast 47.1-in. (1196-mm) PMP value for use in southeast Alaska gives a range in values from 15.1 in. (384 mm) in the north to 16.3 in. (414 mm) in the south based upon the range of 12-hr persisting 1,000-mb (100-kPa) dew points in southeast Alaska for October of 53.5°F (11.9°C) to 55°F (12.8°C) compared to the maximum Gulf of Mexico coast dew point of 78°F (25.6°C) associated with the summer or early fall storm of tropical origin. The additional -10 percent efficiency adjustment reduces the adjusted values to a range of 13.6 to 14.7 in. (345 to 373 mm). A -20 percent efficiency adjustment would result in a range of values from 12.2 to 13.2 in. (310 to 335 mm).

3.4.1.2 Nonorographic Probable Maximum Precipitation Based on Northwest United States Mean Annual Precipitation. An independent method that led to another estimate of nonorographic PMP for southeast Alaska suggested a 24-hr nonorographic PMP of 12 to 14 in. (305 to 356 mm).

Briefly summarized, this method involved:

1. Estimating nonorographic coastal MAP from the latitude of Washington to southeast Alaska.

2. Using nonorographic MAP estimates to determine average orographic effects for extensive inland areas for Washington, British Columbia, and southeast Alaska for MAP.
3. Determining average orographic effects similar to (2) for Washington for 24-hr PMP.
4. Estimating nonorographic PMP off southeast Alaska from values determined in (1), (2), and (3).

Detailed MAP analysis (fig. 19) show coastal Washington State MAP values about 70 in. (1778 mm) ranging from about 65 in. (1651 mm) in the south to about 75 in. (1905 mm) in the north (U.S. Weather Bureau, 1965). In order to estimate roughly how much orography contributes to an average 70-in. (1778-mm) MAP value, we turned to the generalized PMP study for the Northwest States (U.S. Weather Bureau, 1966). Orographic factors near the coast in this study were, first, a 20-percent "stimulation" that was placed in the convergence component of the PMP and, second, an orographic PMP index 6-hr value of 0.5 in. (12.7 mm). Considered together in relation to total PMP, the total orographic effect for coastal PMP amounts to about 30 percent (from "weighting" of total coastal PMP by convergence and orographic components). Thus, if we assume that the stimulation and upwind effects in the MAP (percentagewise) are similar to that for the PMP, then 50 in. (1270 mm) is a reasonable estimate of non-orographic offshore MAP for the coast of Washington State.*

The analyzed MAP chart for our study area (fig. 4) suggests an average coastal MAP of 100 in. (2540 mm) or a little more. A tabulation of MAP was made for southeast Alaska coastal and/or near coastal stations (table 13).

The 165 in. (4191 mm) at View Cove exceeds all others (table 13) by a considerable margin. This suggests the MAP for this station may have been additionally augmented by local terrain conditions and may not be representative of general coastal MAP values. A mean computed by elimination of the value at View Cove is 101 in. (2565 mm). Using the 30 percent orographic adjustment determined for coastal Washington and considering both means suggests an offshore MAP (rounded as with the Washington coast estimate) of about 75 in. (1905 mm).

Using the estimated MAP for offshore Washington State of 50 in. (1270 mm) and for offshore southeast Alaska of 75 in. (1905 mm), we now estimate a value for the British Columbia Pacific Coast by interpolating from figure 16. By this technique we came up with 65 in. (1651 mm) for coastal British Columbia.

These adopted nonorographic MAP values for offshore Washington, British Columbia, and southeast Alaska were used to estimate average orographic effects on MAP. For these estimates, rather large inland areas were chosen opposite each of the designated offshore areas. In outlining the areas for which such

*A reasonable assumption when we consider a large portion of the MAP in this region is made up from general storm events that are smaller events, nevertheless some meteorological causes similar to those that would cause the PMP-event.

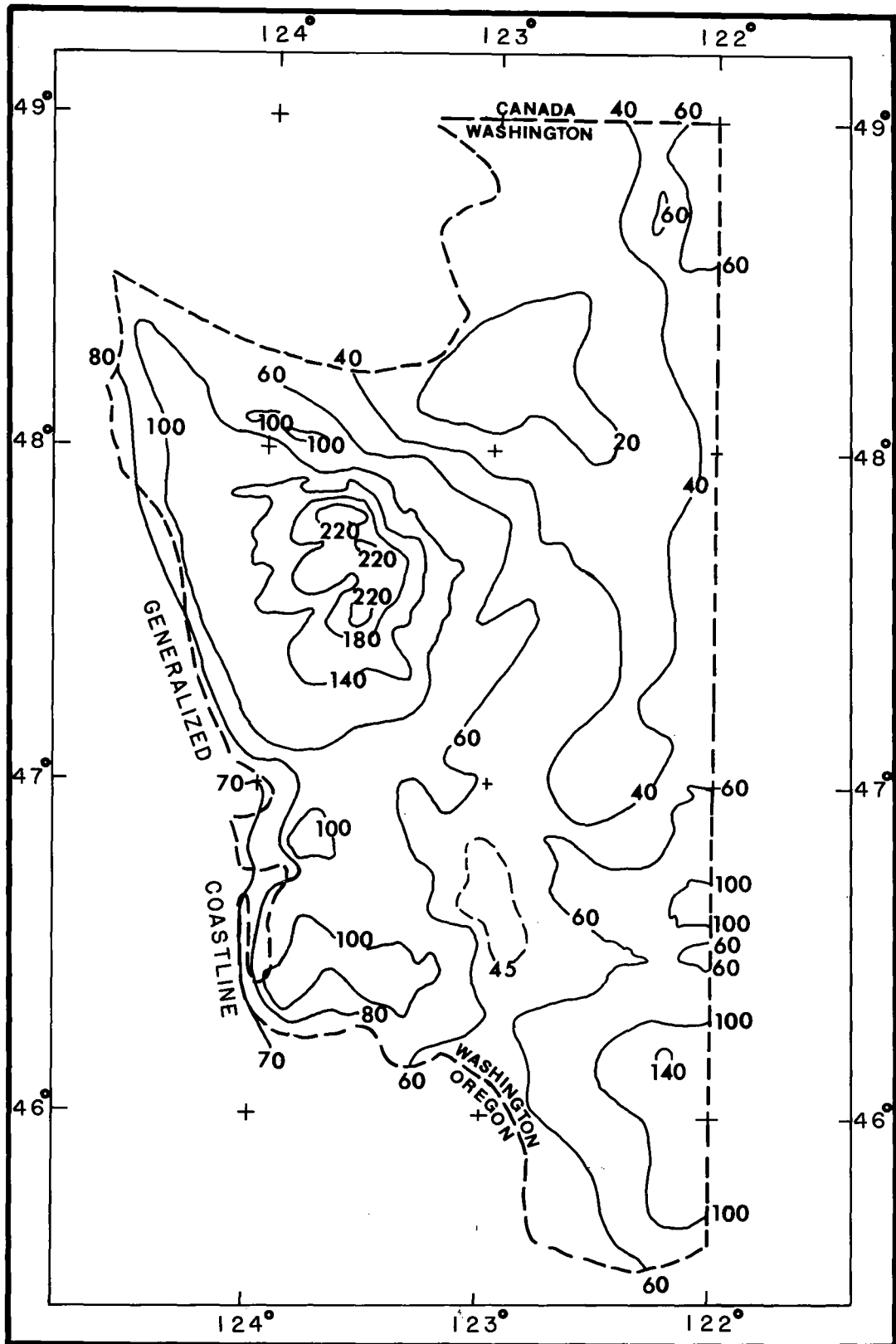

Figure 19.—Area in Washington used for determining average orographic effects. Isolines are mean annual precipitation in inches.

orographic effects were determined, we need to keep in mind the primary purpose to be served by these estimated orographic effects. This purpose was to form judgments on the relation of PMP to MAP, and the general level of PMP.

Table 13.—Mean annual precipitation for coastal and near coastal stations in southeast Alaska

Station Index No.	Station	Mean annual precipitation	
		in.	mm
2	Annette	114	2896
10	Cape Decision	77	1956
11	Cape Spencer	105	2667
12	Chicagof	130	3302
38	Radioville	100	2540
41	Sitka FAA	89	2261
42	Sitka Magnetic	96	2438
46	Treepoint Light Station	98	2489
47	View Cove	165	4191
Mean		108	2743

The complicated and "broken-up" characteristic of topography in our study area favors much variation in orographic effects. However, except for the extreme northwest portion of the study area, there are no especially high and extensive barriers. By contrast, both the British Columbia and western Washington State test areas have some extensive upslopes rising to 6,000 ft (1,829 m) or higher. Such extensive slopes produce both unusual increases (upslope) and decreases (downslope) in precipitation, and thus in MAP. Such extensive barriers also mean, on the average, greater inland sheltering downwind of the most prominent barriers. The use of rather large areas, so as to incorporate a reasonably substantial amount of topography similar to southeast Alaska, helps to make the resulting ratios more meaningful than if small areas with associated greater uncertainty were used. The areas chosen for British Columbia and for western Washington are shown in figures 19 and 20, respectively. For our study area and the other two areas, MAP values at grid points (with 1/4° spacing) were averaged and from this gridding mean orographic increases were determined for each inland area on the basis of a comparison with the adopted offshore non-orographic MAP value for each of the three areas: 50, 65, and 75 in. (1270, 1651, and 1905 mm), respectively. These increases are shown in table 14.

Table 14.—Mean orographic increases

Area	Category	Net orographic percent
Washington	MAP	33
British Columbia	MAP	40
Southeast Alaska	MAP	68
Washington	PMP	38
Oregon	PMP	31

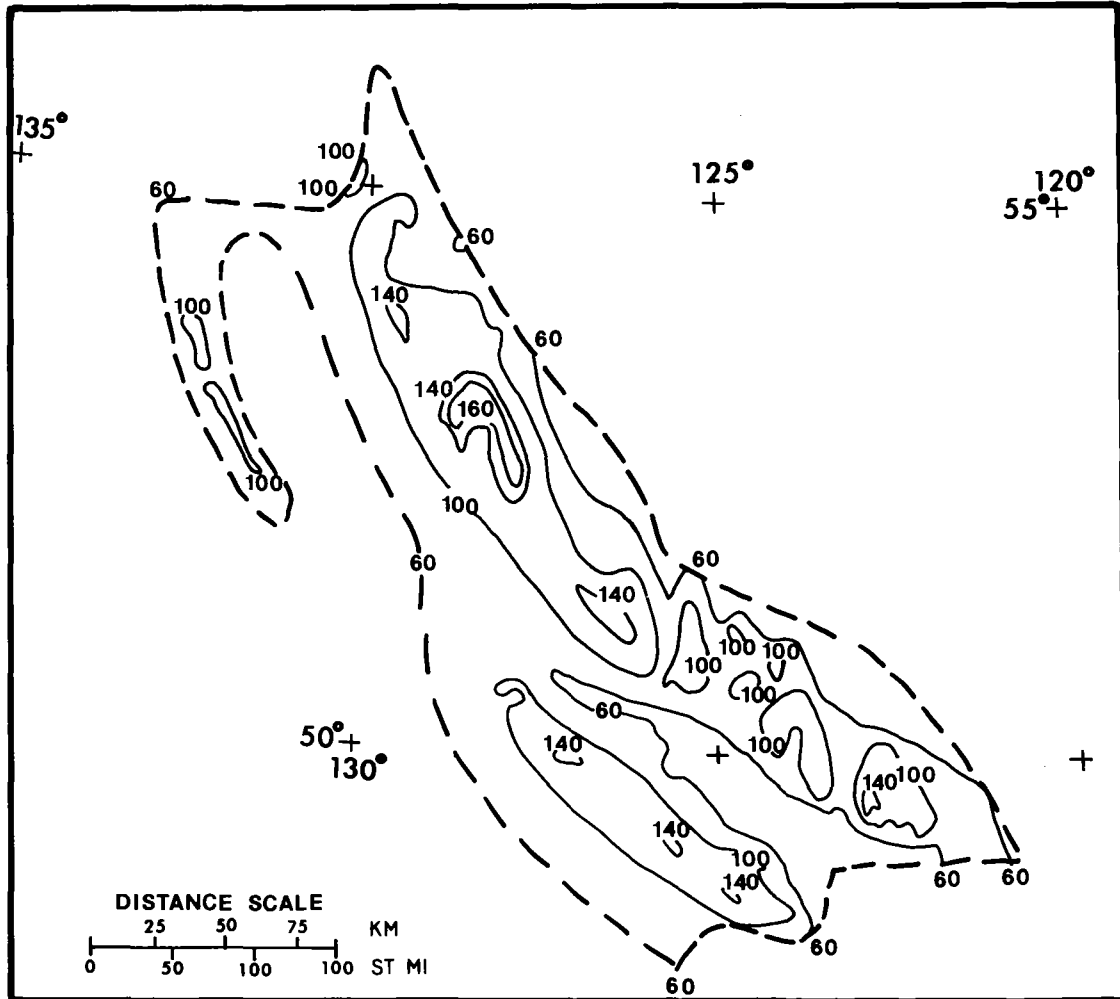

Figure 20.—Area in British Columbia used for determining average orographic effects (after Walker, 1961). Isolines are mean annual precipitation in inches.

A comparison of net orographic effects using generalized PMP values for the Northwest States, (U.S. Weather Bureau, 1966) for the area west of 122°W. in Washington resulted in an average inland orographic effect of +38 percent. The basis for this was the use of an offshore 12-in. (305-mm) nonorographic 24-hr, 10-mi² (26-km²) PMP. Similarly, for the portion of Oregon west of 122° W., the average orographic effect was computed to be +31 percent. These values are also shown in table 14.

The trend in overall net orographic effects for the MAP category compared to the Washington area showed an increase from Washington to British Columbia with an additional and more pronounced increase for southeast Alaska. We suggest this increasing trend northward is largely due to the increasing net orographic

exposure (directionwise) that exists northward along the coast. This greater exposure directionwise allows MAP to build up more to the north as more variation in wind direction can be utilized efficiently both during a particular storm and among different storms. In addition, for the western Washington and Oregon areas, inland of the coastal mountains, there is more substantial sheltering than in British Columbia and especially more so than in southeastern Alaska. Using rather large areas integrated these various factors.

3.5 First Approximation of Probable Maximum Precipitation and Modification

3.5.1 First Approximation of Probable Maximum Precipitation

We used the MAP chart (fig. 6) and the adopted relation of figure 18 to give a first approximation to 24-hr, 10-mi² (26-km²) PMP. This resulted in a range of PMP values from a minimum of 12 in. (305 mm) to a maximum of 28 in. (711 mm). This range in PMP values is for a range of MAP values of from 50 to 300 in. (1270 to 7620 mm).

We now make use of the data of table 14 for an evaluation of reasonable assumptions of various magnitudes of nonorographic offshore PMP. In connection with such an evaluation, we also should be aware that prior PMP estimates for the Pacific coastal region of the United States indicated only small variations in the nonorographic 24-hr 10-mi² (26-km²) PMP with latitude. Apparently, the lowering moisture values with increasing latitude are counter-acted by stronger winds. Thus, as these two factors combine, there is a limitation of the latitudinal variation of moisture convergence that takes part in the production of maximum nonorographic rainfall.

Using the mean first approximation 24-hr 10-mi² (26 km²) PMP for the study area (fig. 1), which was estimated to be 18.3 in. (465 mm) with an assumed 12 in. (305 mm) nonorographic 24-hr, 10-mi² (26-km²) PMP, gives a mean indicated orographic increase of 52 percent. Assuming a 14-in. (356-mm) non-orographic value makes the orographic increase 32 percent. This range of 32 to 52 percent brackets the mean of 42 percent from the five individual percentages of table 14. Percentages go well outside this range of 32 to 52 percent when we assume either a 10-in. (254-mm) (83 percent) or a 16-in. (406-mm) nonorographic PMP (16 percent). From these comparisons we conclude, therefore, that the best estimate of nonorographic component lies between 12 and 14 in. (305 and 356 mm). This range in 24-hr 10-mi² (26-km²), PMP is close to the range one obtains utilizing the U.S. maximum PMP with an efficiency adjustment (to supplement the moisture adjustment) of -10 to -20 percent (sec. 3.4.1.1).

3.5.2 Modification of First Approximation Probable Maximum Precipitation

The first approximation PMP (not shown) was derived from a straightforward objective application of the adopted relation of MAP to PMP from figure 18 to the MAP chart (fig. 6). Modification to this first approximation came from the following sources:

- a. Relation of station maximum 24-hr precipitation values to MAP and resulting anomaly analysis.
- b. Conclusions of significant features of heavy precipitation-producing weather situations in southeast Alaska with particular attention to orographic effects.

- c. Trying various techniques for estimating the general level of PMP for the most protected regions between the coast and the interior continental upslopes.

3.5.2.1 Relation Between Maximum Observed 24-hr Precipitation and Mean Annual Precipitation. There were 49 stations in southeast Alaska where daily or hourly data were available to determine maximum 24-hr precipitation amounts. For these stations (table 15), a relation was developed between the maximum observed values and MAP. For those stations listed in table 15 where only maximum observation-day rains of record were available, 24-hr maxima were estimated by increasing the daily observation-day maximum by 13 percent (U.S. Weather Bureau, 1960).

The plot of 49 station maximum 24-hr amounts versus MAP and the fitted linear regression are shown in figure 21. The correlation coefficient is 0.68 and the standard error of estimate 1.5 in. (38 mm). The departure of the individual values of figure 21 from the regression line were used in an anomaly analysis as an aid to adjusting PMP values from the first approximation PMP map derived using the MAP as an index.

3.5.2.1.1 Anomaly analysis. For the study area, a large number of the stations whose maximum daily rains exceeded the values indicated by the mean relation of figure 21 were found to be located in protected areas. This indicated that 24-hr rainfall potential for such sheltered or protected areas was greater than that estimated from a long-duration index such as the MAP. The analysis of the anomalies (not shown) also indicated that, in general, greater PMP potential than that tied to the MAP was indicated from about 56°N northward.

3.5.2.2 Clues from Storm Situations. Weather maps for a selection of heavy rain cases were investigated with the objective of finding clues for the logical adjustment of the PMP. Many different weather systems were investigated. Four cases were especially helpful in providing insight into the adjustment of the PMP maps.

3.5.2.2.1 August 3-7, 1920. This was an outstanding storm producing a 1-day rain of 8.20 in. (208 mm) at Ketchikan on August 5. The 3-day rain (19.54 in., 496 mm) for this storm was used with adjustments as one technique for estimating a range in PMP for specific basins (sec. 3.4). Assuming the isobar orientation (fig. 22) is indicative of the flow at about 2,000 ft (610 m) or so above sea level, we suggest that rather strong orographic effects around Ketchikan, for example, were part of the causes of the rainfall in this storm. Winds at very low levels would avoid barriers, while at around 2,000 ft (610 m) the winds could overtop upwind barriers and thereby utilize the southwest-facing upslopes of this area for adding an orographic component to the rain.

3.5.2.2.2 September 25-28, 1918. Record 1-day rains occurred in this storm at Juneau City, Perserverance Camp, and Speel River (table 15). Although the strong on-shore gradient and rapidly moving systems are features common to many storms that affect our study area, the pronounced backing of the low-level winds (indicated by the orientation of the isobars on the surface chart for the 26th compared to the isobar orientation the following morning) suggested a departure of flow that permitted a more effective avoidance of barriers than is ordinarily the case in intense low-pressure systems. Surface weather maps for this storm are shown in figure 23.

Table 15.—Station precipitation data for southeast Alaska

Index no.	Station	Lat.		Long.		Elevation		Daily maximum		1.13 X daily maximum		Date	Length of record (yrs)*	Mean annual precipitation	
		(°)	(')	(°)	(')	(ft.)	(m)	(in.)	(mm)	(in.)	(mm)			(in.)	(mm)
1	Angoon	57	30	134	35	35	11	2.40	61	2.71	69	9/19/42	29	38	965
2	Annette (R)	55	02	131	34	110	34	7.59	193	-	-	10/20-21/58	29	114	2896
3	Annex Creek	58	19	134	06	24	7	6.05	154	6.84	174	10/13/45	53	114	2896
4	Auke Bay	58	23	134	38	42	13	2.87	73	3.24	82	9/29/70	8	62	1575
5	Baranof	57	05	134	50	20	6	5.98	152	6.76	172	10/14/42	24	147	3734
6	Beaver Falls	55	23	131	28	35	11	6.70	170	7.57	192	9/23/67	24	151	3835
7	Bell Island	55	55	131	35	10	3	4.60	117	5.20	132	10/2/30	21	109	2769
8	Calder	56	10	132	27	20	6	4.54	115	5.13	130	1/13/22	13	112	2845
9	Canyon Island	58	33	133	41	85	26	3.98	101	4.50	114	2/24/38	9	61	1549
10	Cape Decision	56	00	134	08	39	12	4.66	118	-	-	10/25-26/44	27	77	1956
11	Cape Spencer	58	12	136	38	81	25	8.60	218	-	-	10/21-22/48	34	105	2667
12	Chicagof	57	40	136	05	10	3	4.78	121	5.40	137	9/13/52	6	130	3302
13	Craig	55	29	133	09	15	5	5.15	131	5.82	148	10/5-6/46	17	111	2819
14	Eldred Rock	58	58	135	13	55	17	7.03	179	7.94	202	10/24/47	26	46	1168
15	Five Finger Light Sta.	57	16	133	37	70	21	3.55	90	4.01	102	8/10/69	28	56	1422
16	Fortmann Hatchery	55	36	131	25	132	40	5.10	130	5.76	146	8/10/15	13	150	3810
17	Glacier Bay	58	27	135	53	50	15	3.63	92	4.10	104	8/23/66	5	81	2057
18	Guard Island	55	27	131	53	20	6	4.47	114	5.05	128	11/16/43	22	66	1676
19	Gull Cove	58	12	136	09	18	5	6.50	165	-	-	10/9-10/46	12	99	2515
20	Gustavus FAA	58	25	135	42	22	7	3.69	94	4.17	106	10/6/43	31	54	1372
21	Haines I S	59	14	135	26	100	30	5.64	143	-	-	10/9-10/44	32	61	1549
22	Haines Terminal	59	16	135	27	175	53	3.76	96	4.25	108	12/5/64	17	50	1270
23	Hollis	55	28	132	40	15	5	5.06	129	5.72	145	10/14/61	10	103	2616
24	Hydaburg (Sulzer)	55	12	132	49	25	8	6.07	154	6.86	174	11/14/17	5	142	3607
25	Juneau City #2	58	18	134	24	25	8	5.64	143	-	-	9/25-26/18	54	93	2362
26	Juneau WBAP (R)	58	22	134	35	12	4	4.66	118	-	-	10/9-10/46	28	54	1372
27	Kake	56	59	133	57	8	2	3.84	98	4.34	110	10/29/30	11	56	1422
28	Kasaan	55	38	132	34	28	9	3.53	90	3.99	101	12/17/19	15	86	2184
29	Ketchikan	55	21	131	39	15	5	8.07	205	9.12	232	8/5/20	54	162	4115
30	Lincoln Rock L.S.	56	03	132	46	25	8	4.30	109	-	-	2/20-21/47	22	64	1626

Table 15.—Station precipitation data for southeast Alaska (continued)

Index no.	Station	Lat.		Long.		Elevation		Daily maximum		1.13 X daily maximum		Date	Length of record (yrs)*	Mean annual precipitation	
		(°)	(')	(°)	(')	(ft.)	(m)	(in.)	(mm)	(in.)	(mm)			(in.)	(mm)
31	Linger Longer	59	26	136	17	700	213	2.80	71	3.16	80	11/25/63	7	34	864
32	Little Port Walter	56	23	134	39	14	4	14.84	377	16.77	426	12/6/64	34	222	5639
33	Moose Valley	59	25	136	03	400	122	4.75	121	5.37	136	10/29/49	12	31	787
34	Perserverance Camp	58	18	134	20	1400	427	7.40	188	8.36	212	9/26/18	4	155	3937
35	Petersburg	56	49	132	57	50	15	5.70	145	6.44	164	10/21/37	40	106	2692
36	Point Retreat Light	58	25	134	57	20	6	5.65	144	6.38	162	12/28/56	23	71	1803
37	Port Alexander	56	15	134	39	18	5	7.62	194	8.61	219	7/7/52	14	176	4470
38	Radioville	57	36	136	09	15	5	6.81	173	7.70	196	10/13/39	15	100	2540
39	Seclusion Harbor	56	33	134	03	20	6	5.24	133	5.92	150	11/30/36	9	115	2921
40	Shelter Island	58	23	134	52	10	3	2.88	73	3.25	82	2/9/30	15	55	1397
41	Sitka FAA	57	04	135	21	15	5	5.37	136	6.07	154	9/20/54	23	89	2261
42	Sitka Magnetic	57	03	135	20	67	20	6.42	163	7.25	184	9/9/48	73	96	2438
43	Skagway	59	27	135	19	18	5	5.25	133	-	-	10/9-10/44	29	27	686
44	Speel River	58	08	134	44	15	5	8.86	225	10.01	254	9/26/18	9	139	3531
45	Tenakee	57	47	135	12	19	6	4.17	106	4.71	120	10/30/49	8	64	1626
46	Treepoint Light Sta.	54	48	130	56	36	11	4.50	114	5.09	129	9/23/67	37	98	2489
47	View Cove	55	04	133	04	13	4	5.51	140	6.23	158	12/15/36	15	165	4191
48	Wrangell	56	28	132	23	37	11	4.51	115	5.10	130	1/30/62	50	80	2032
49	Yakutat WBAP (R)	59	31	139	40	28	9	7.13	181	-	-	11/27-28/56	49	132	3353

- Recorder (not adjusted by 1.13)

* Data through 1972

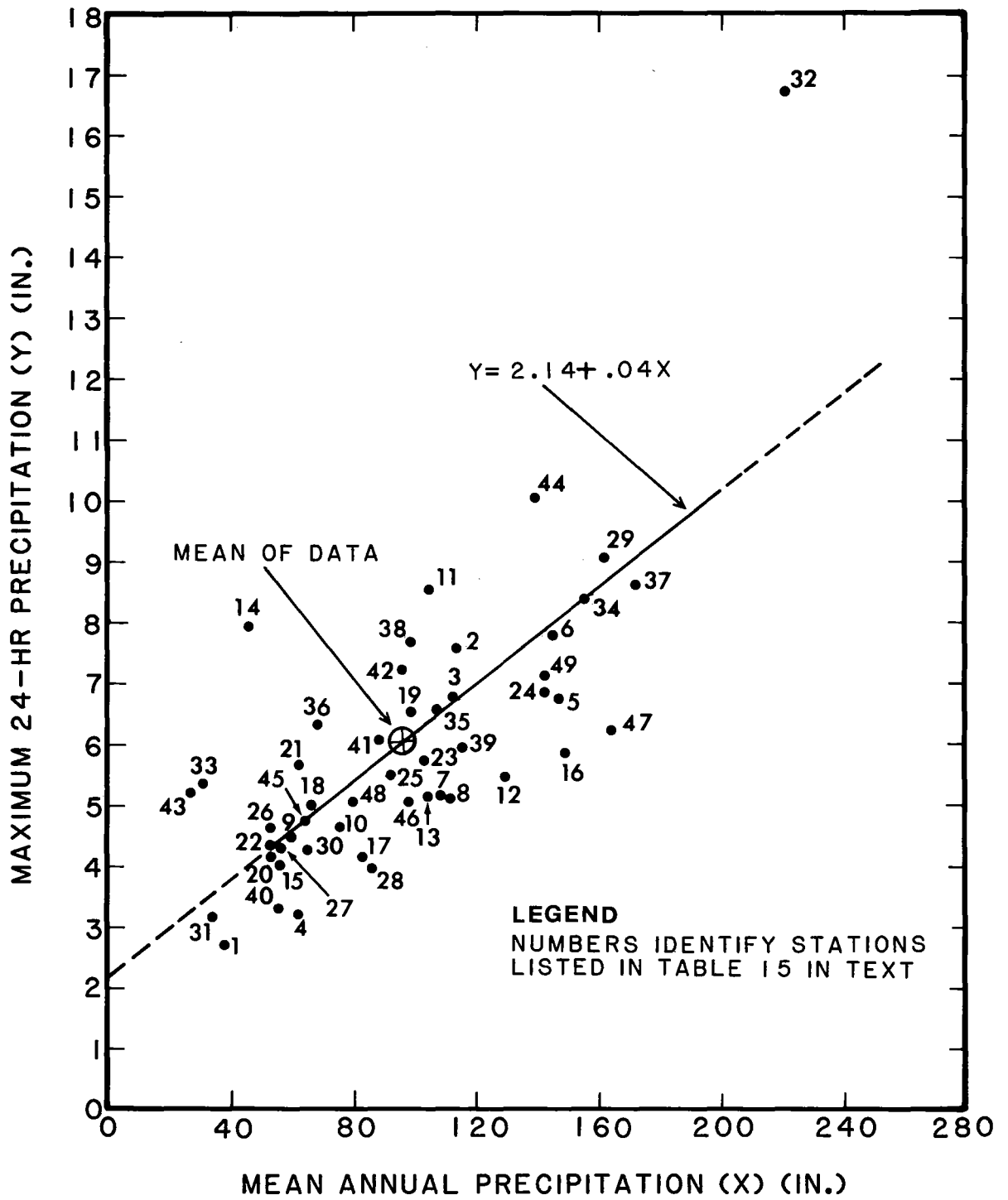
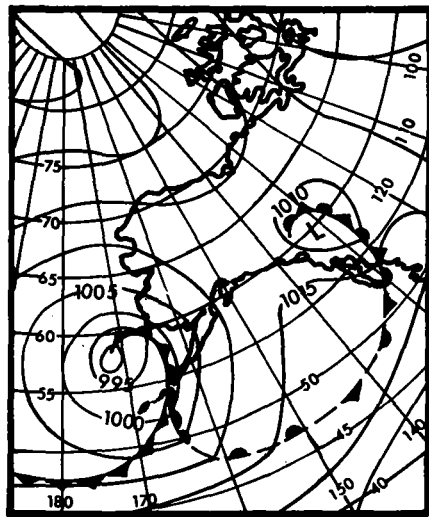
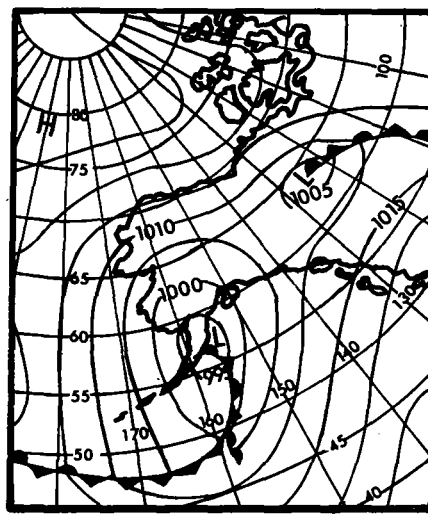

Figure 21.—Maximum observed 24-hr precipitation vs. mean annual precipitation for southeast Alaska.



AUG. 3, 1920 (1300 GMT)



AUG. 4, 1920 (1300 GMT)

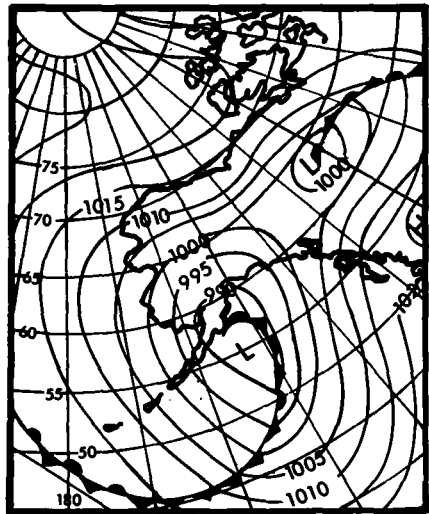

AUG. 5, 1920 (1300 GMT)

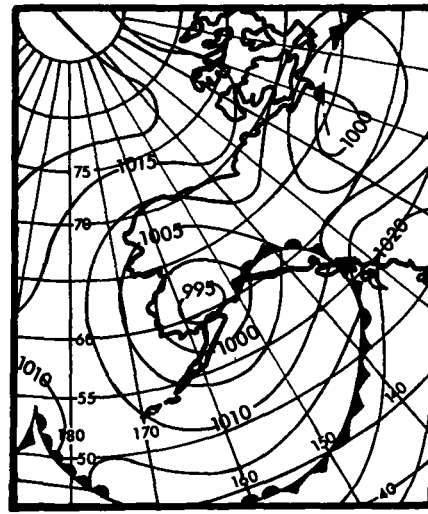

AUG. 6, 1920 (1300 GMT)

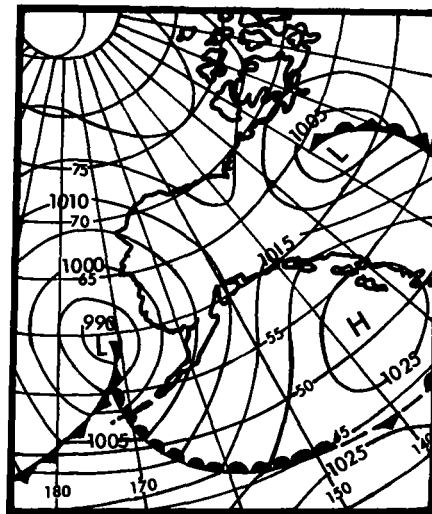

AUG. 7, 1920 (1300 GMT)

Figure 22.—Surface weather maps for August 3–7, 1920.

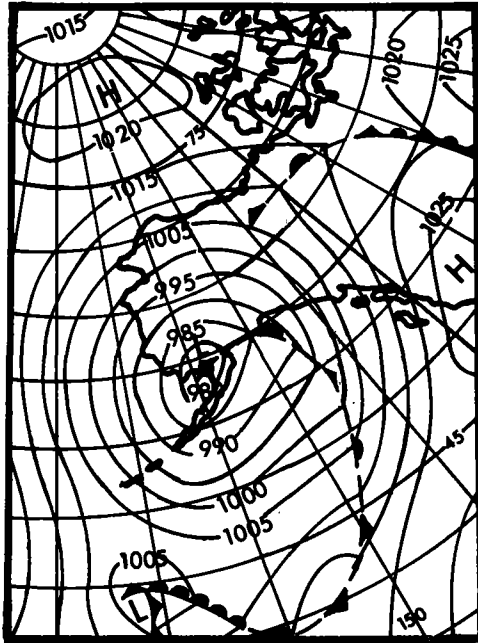

SEPT. 25, 1918 (1300 GMT)

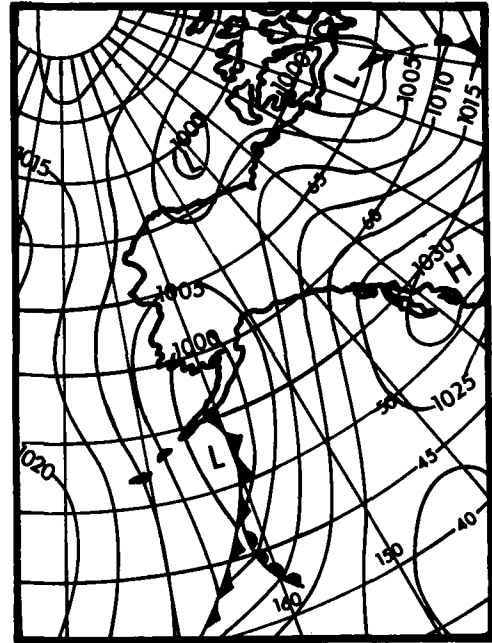

SEPT. 26, 1918 (1300 GMT)

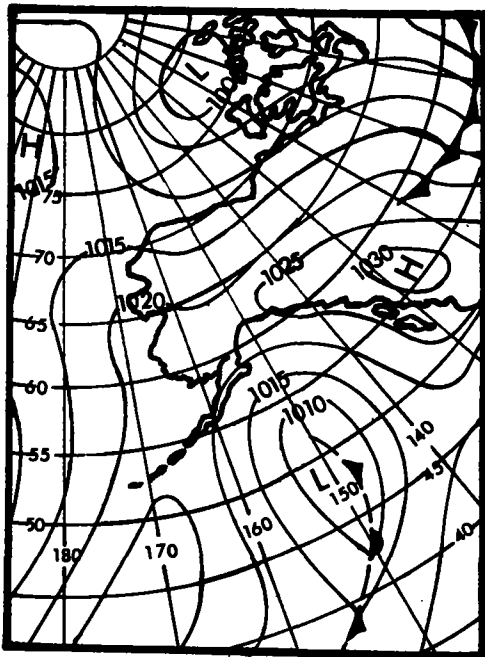

SEPT. 27, 1918 (1300 GMT)

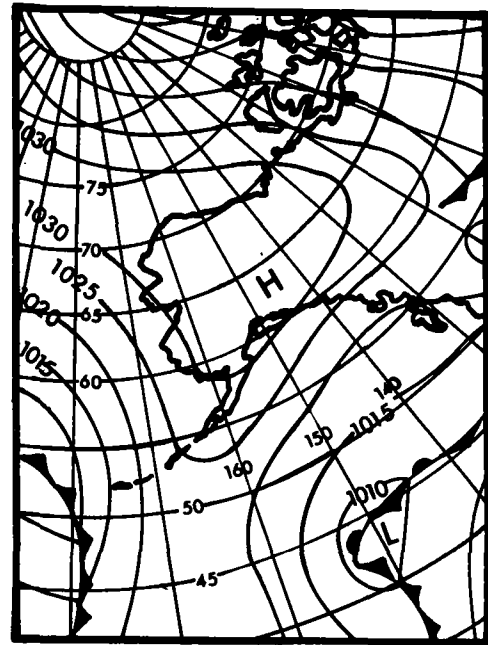

SEPT. 28, 1918 (1300 GMT)

Figure 23.—Surface weather maps for September 25–28, 1918:

3.5.2.2.3 December 4-7, 1964. Surface maps for this storm are shown in figure 24 and upper-air (500-mb) charts in figure 25. Except that the maps indicate an intense system with strong flow from a low latitude, definitive features of why unusual rains resulted are not evident. The surface and 500-mb charts for this storm show that our study area in general is in about the center of the strongest on-shore flow through the lower levels of the atmosphere. This particular storm produced record rains at both a very rainy location, Little Port Walter where the MAP is 222 in. (5639 mm), and at a very sheltered or dry location, Haines Terminal, where the MAP is only 50 in. (1270 mm). The amount at Haines Terminal is a higher percentage of it's MAP than the value at Little Port Walter.

3.5.2.2.4 July 6-11, 1969. This heavy rain producing midsummer storm which gave Little Port Walter 9.55 in. (243 mm) on July 9 is illustrative of the fact that basically the same type of broadscale weather situation is responsible for summer rains as well as cool-season rains. Figure 26 shows the surface maps for this storm beginning with the map for July 8.

3.5.2.2.5 Summary. Based partly upon the clues from the four specific storm cases but also on others for which maps are not shown, one should be quite liberal in permitting variation in the PMP gradients, etc., that are not adequately defined by a relation of PMP to MAP. Topographic features, for example, as indicated on a topographic map (or a generalized version of such a map) should be given careful consideration in making adjustments to a first approximation of a PMP map that is influenced strongly by the MAP distribution. In other words, we know from what is possible in wind variations, etc., in rain-producing systems that slopes facing varying directions may be utilized more efficiently in particular situations than one would judge from MAP variations only. Thus, knowing the weather variations possible, one needs to give keen attention to the topography in making adjustments to the first-approximation chart.

The survey of weather features in large precipitation-producing storms in southeast Alaska showed that one can only guess how the interplay of winds with the complicated topography results in a significant rain at a particular place, e.g., storm of December 4-7, 1964 (sec. 3.5.2.2.3). We know from experience that for other areas of complicated orography somewhat altered weather conditions may increase the rainfall potential, especially in ordinarily "sheltered" regions where MAP and other such indices do not give sufficient clues to the full potential. Toward this end an evaluation of the orography in relation to the rare event is essential in the modification of the first-approximation PMP chart.

The following are suggested as clues to modifying the MAP features for greater consistency in PMP conditions from our study of heavy general rain cases in this orographic region:

- a. Situations that involve rapidly changing winds or situations with a distinct (and somewhat out-of-the-ordinary) variation of wind with height may promote more efficient rain production in a particular area. Judgment on the tie-in with the particular orographic configurations of an area must be made.

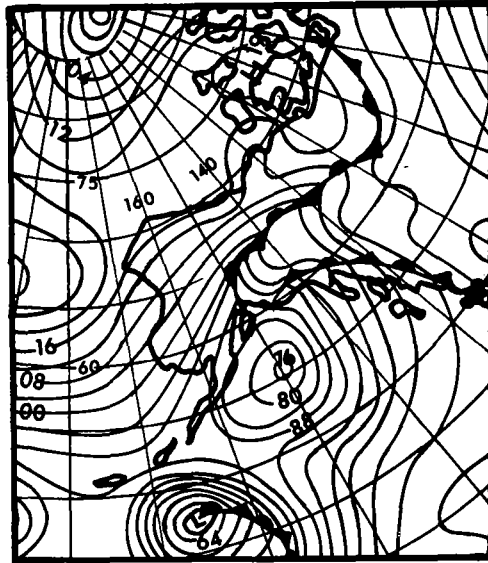

DEC. 4, 1964 (1200 (GMT)

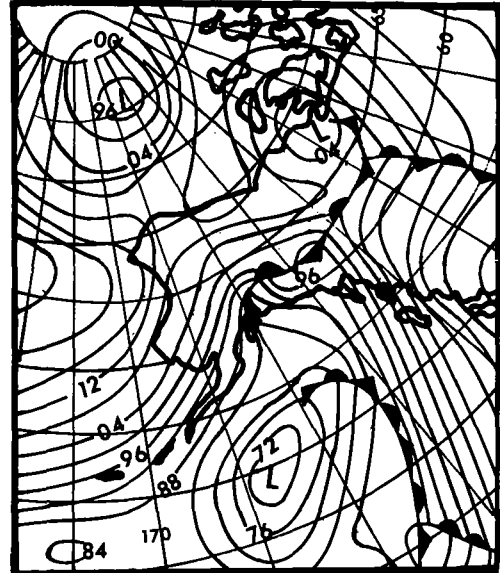

DEC. 5, 1964 (1200 GMT)

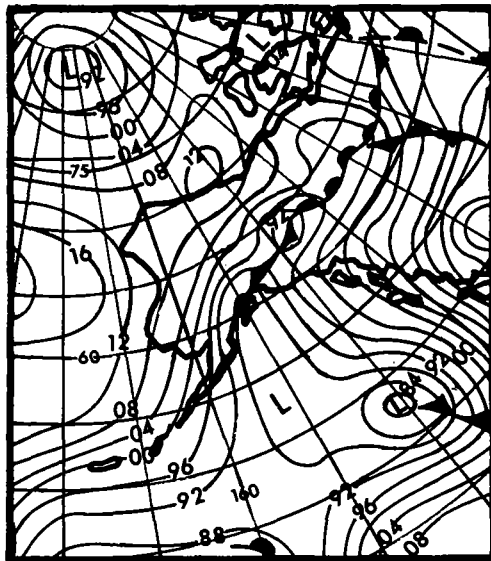

DEC. 6, 1964 (1200 GMT)

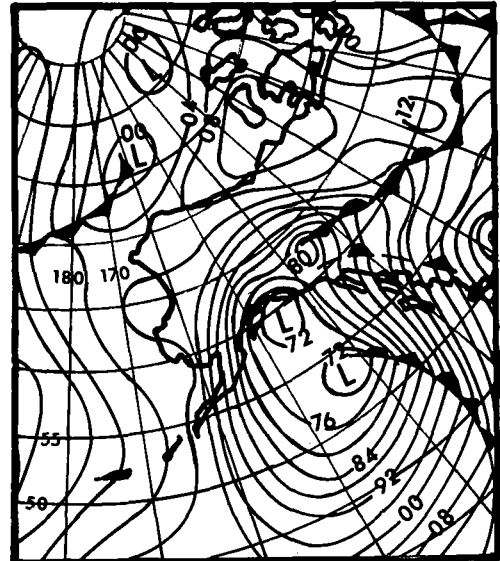

DEC. 7, 1964 (1200 GMT)

Figure 24.—Surface weather maps for December 4-7, 1964.

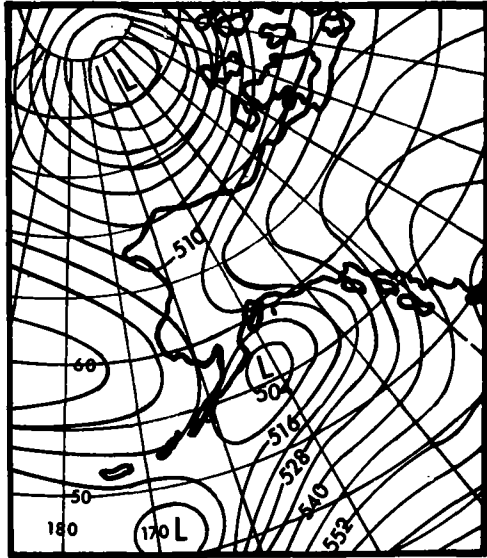

DEC. 4, 1964 (1200 GMT)

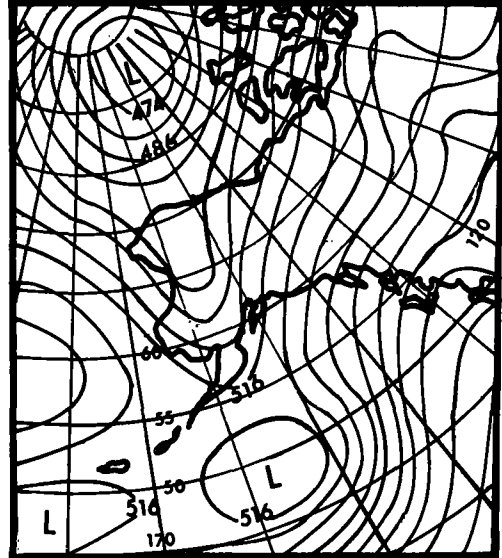

DEC. 5, 1964 (1200 GMT)

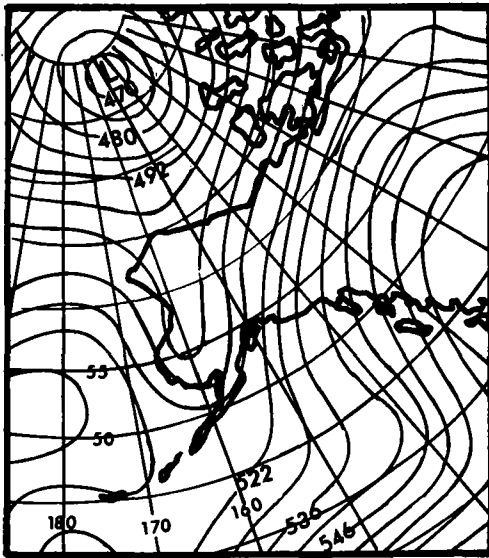

DEC. 6, 1964 (1200 GMT)

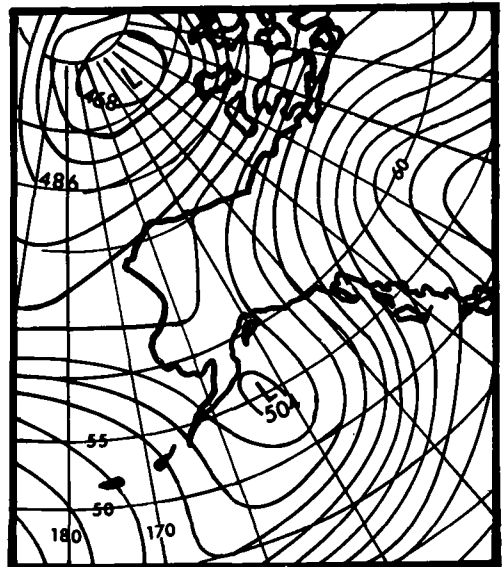

DEC. 7, 1964 (1200 GMT)

Figure 25.—Upper-air (500-mb) weather maps for December 4-7, 1964.

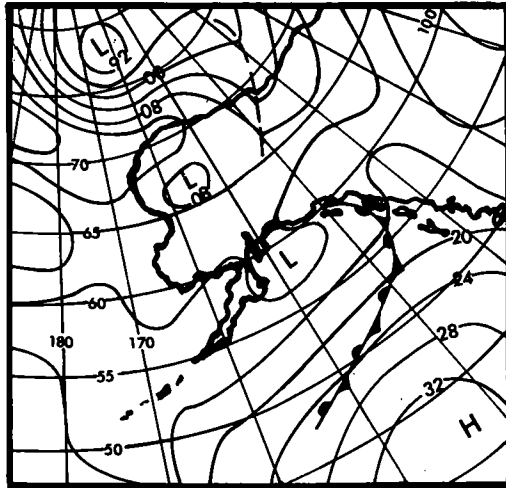

JULY 6, 1969 (1200 GMT)

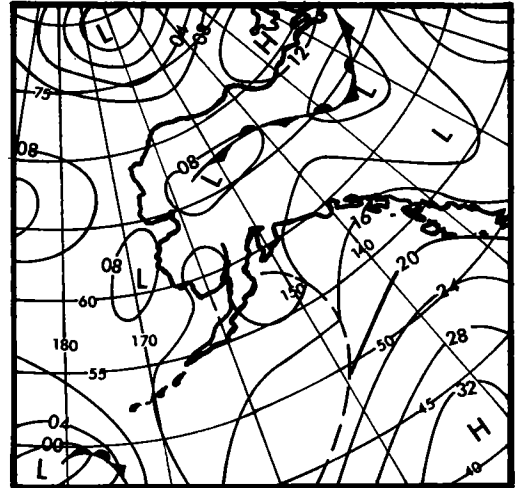

JULY 7, 1969 (1200 GMT)

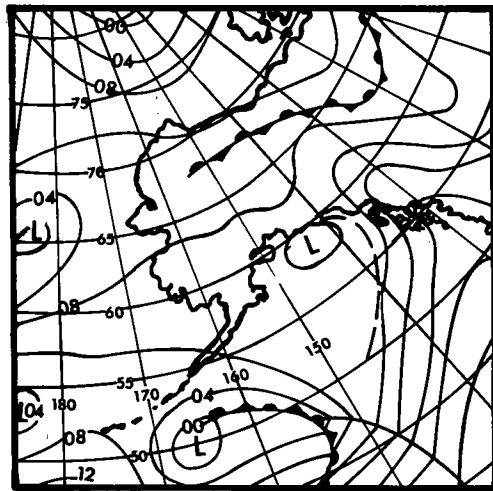

JULY 8, 1969 (1200 GMT)

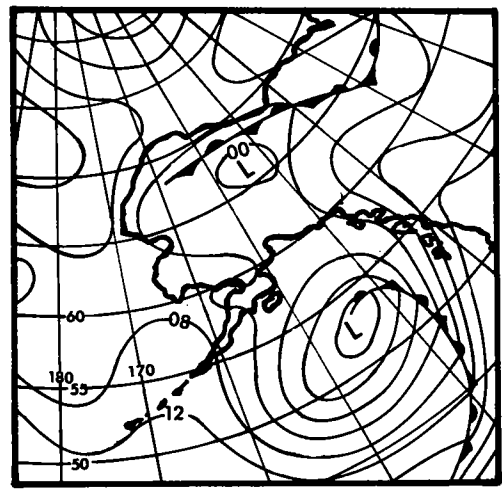

JULY 9, 1969 (1200 GMT)

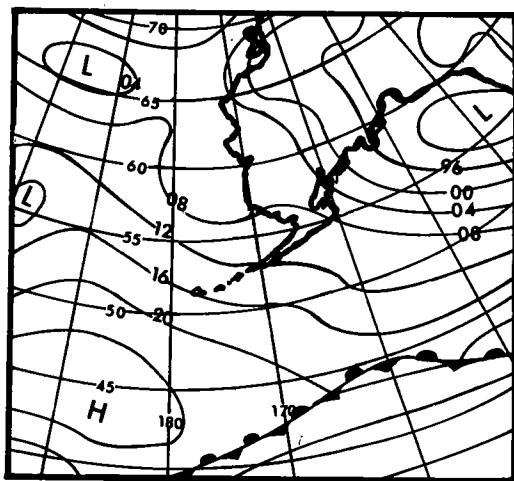

JULY 10, 1969 (1200 GMT)

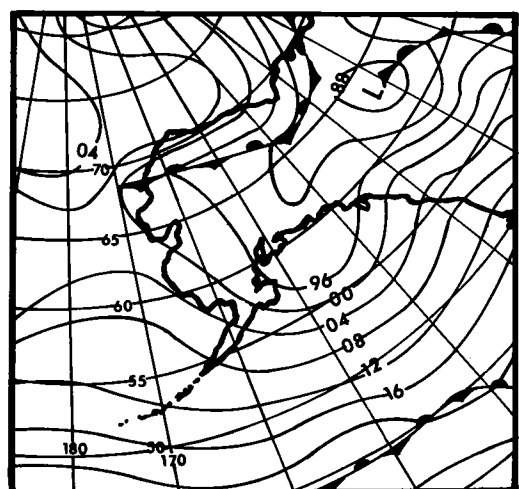

JULY 11, 1969 (1200 GMT)

Figure 26.—Surface weather maps for July 6–11, 1969.

- b. Situations involving rapid motion and/or strong fronts may produce large convergence components of precipitation allowing relatively "protected areas" to receive more precipitation than one might otherwise assign to such areas.
- c. We know that many slight variations in prevailing synoptic weather patterns are possible. These variations during a storm may promote the efficient integrated use of prevailing topography in particular regions. Persistence magnifies such effects with time. For example, around Ketchikan, low level winds from the south could be channeled by the terrain. Contrasting to the low-level wind effects in this area, winds a few thousand feet higher need to vary in direction in order to utilize particular orographic upslopes. A particular slope may have its effect on rainfall accentuated more during a single storm event than in the MAP.

3.5.2.3 Establishment of the Probable Maximum Precipitation General Level for Sheltered Region. In a recent generalized PMP estimate for the Southwest States (Hansen et al., 1977), nearly all areas were considered susceptible to at least some orographic rainfall in the PMP storm. Following this principle which (for ordinarily sheltered areas) is based mainly upon "carry-along" of precipitation particles, we should expect some net positive orographic effect in the PMP in all places in southeast Alaska. Since the overall orographic sheltering in southeast Alaska is generally less than in the Southwest States, the orographic effects in southeast Alaskan sheltered areas should be more than minimal.

To evaluate the first-approximation PMP in sheltered areas, we start with the range of nonorographic PMP estimates from the offshore MAP approach (sec. 3.4.1.2) of 12 to 14 in. (305 to 356 mm) and the values based on United States nonorographic values (sec. 3.4.1.1) of 13.7 to 14.7 in. (348 to 373 mm). Combining these, we will use a rounded range of about 12 to 15 in. (305 to 381 mm). What we wish to determine is what the magnitude of the PMP ought to be in the portions of the interior of southeast Alaska where the PMP is believed to be the lowest (i.e., the most sheltered regions where we postulate some positive orographic effect is still realistic).

Using a PMP 12-hr persisting dew point of 55°F (12.8°C) with a 2,000-ft (610-m) barrier gives an adjustment of -22 percent. This is based upon a moist adiabatic vertical distribution of moisture associated with the 1,000-mb, 12-hr persisting dew point of 55°F (12.8°C). The 12- to 15-in. (305- to 381-mm) range of non-orographic values, by applying the -22 percent, becomes 9.4 to 11.7 in. (239 to 297 mm). Computations are also made using a 1,000-ft (305-m) barrier. The resulting reduction is -12 percent. Thus, the adjusted PMP estimates for the 1,000-ft (305-m) barrier are 10.6 to 13.2 in. (269 to 335 mm).

To sum up the above results:

- a. Unsheltered non-orographic PMP - 12 to 15 in. (305 to 381 mm).
- b. 1,000-ft (305 m) barrier PMP - 10.6 to 13.2 in. (269 to 335 mm).

- c. 2,000-ft (610-m) barrier PMP - 9.4 to 11.7 in.
(239 to 297 mm).

These values (depending upon barrier assumptions) represent minimum PMP values when we assume zero net orographic effects. A modest net orographic component assumption for all areas as in the recent report on PMP for the southwest states (Hansen et al., 1977) requires increasing these values.

3.5.2.4 Examples of Modifications to First-Approximation Probable Maximum Precipitation. In the vicinity of the main coastline or segments of coastlines facing the ocean, first-approximation PMP values are increased approximately 20 percent for stimulation and upwind upslope effects (sec. 3.4.1.2). Such effects on rainfall are not adequately portrayed in terms of the tie-in of PMP with a generalized MAP chart.

Conforming to the overall indications of the anomaly analysis (sec. 3.5.2.1.1), changes to the first approximation PMP south of about 56°N. were kept quite small. However, just north of 56°N is a region (between 132°W and 134°W. and up to 57°N.) comprised of numerous islands. On the whole, this is an area that may be classified as being sheltered. Hence, in line with previous points, an overall increase of PMP is suggested for this area (sec. 3.5.2.1.1 and 3.5.2.2.5). However, 5 or 6 sub-areas (within this rather large area) with the most favorable upslopes were singled out for somewhat higher increases than the overall general average for the area. In addition, our aim was to make these adjustments so that consistency in overall detail would result for the whole study area.

Bordering the main interior upslopes in the west (north of 57°N.) is an extensive long body of water called Stephens Passage. To the west of Juneau, the water extends to the northwest where it joins the Lynn Canal. We increased the PMP about 4 inches over most of these protected water areas and over the adjoining areas of upslope. We judge in such protected or sheltered areas that specific wind conditions (so as to utilize particular upslopes, etc.) can produce PMP values reasonably above those derived from a straight-forward objective tie-in with MAP that gives the first-approximation values. In the extreme northern part of the Lynn Canal, and nearby surroundings, we do not significantly increase the PMP for two reasons:

- a. This area is so extremely well sheltered we did not consider it realistic to depart significantly from the first-approximation value.
- b. To give a minimum PMP higher than 13 in. (330 mm) in this area would make this extremely sheltered region's PMP too high in relation to less well-sheltered areas. In other words, for consistency the general level of all sheltered areas would need to be raised (sec. 3.5.2.3).

Another modification to the first-approximation chart involved an increase in the areal coverage of the maximum PMP on the interior upslopes. This procedure resulted in increases in PMP due to the stimulation effects at the lower elevations and due to upslope effects at the higher elevations.

In the extreme northwest portion of our study area, some extreme and extensive upslopes exist (associated with the Fairweather mountain range). In this area, we have placed a small 10-mi² (26-km²) PMP of 32 in. (813 mm). This is in agreement with the general level of PMP discussed earlier (sec. 3.4) in connection with similar extreme and extensive upslope conditions along the west coast region of the United States.

3.5.3 Adjusted 24-hr, 10-mi² Probable Maximum Precipitation Chart

Using such guidance as discussed under 3.5.2, the first-approximation PMP chart was adjusted. The final PMP is shown in figure 27. The absolute range in PMP values is from a low of 13 in. (330 mm) to a high of 32 in. (813 mm). When compared to the first-approximation values, adjusted PMP values in many sheltered regions were raised 2 to 3 in. (51 to 76 mm) with some increases of around 4 in. (102 mm).

3.6 Summary Remarks

Maximum use was made of southeast Alaskan data for developing a PMP chart with a realistic degree of orographic detail. A primary aim was to provide realistic consistency, particularly with regard to orography, in basin PMP estimates. The degree of detail is greater than the earlier generalized study (Miller, 1963). We believe the detail is consistent with that of other recent studies in regions of complicated topography (e.g., Hansen et al., 1977).

3.7 Seasonal Variation of Probable Maximum Precipitation for Basins in Southeast Alaska

Due to the possibility that snowmelt, combined with less than the all-season PMP, might produce a more critical flood, an estimate of PMP for use in the snowmelt season is necessary. The adopted seasonal variation of PMP is based upon a synthesis of previous seasonal variation work for Alaska with some additional data analysis and regional smoothing of adopted relations.

3.7.1 Data and Analysis

A summary of the maximum daily rains of record for the 49 stations listed in table 15 substantiates the conclusions regarding season of extreme rains from prior individual basin estimates and from Technical Paper No. 47 (Miller, 1963). The most obvious conclusion from the summary of maximum rains in table 15 is that October is the month most likely to experience maximum daily rains in southeast Alaska. The table 15 summary put in the form of a histogram of months of maximum daily rains is shown in figure 28.

For the purpose of defining a PMP during the snowmelt season for southeast Alaska, we need to consider variation in winds, storm efficiency, moisture, etc. Other studies north and south of our region have previously investigated these material variations. In Washington, the all season PMP can occur in October and early winter (U.S. Weather Bureau 1966). To the north of our study area along the south coast of Alaska, several estimates of PMP by the Hydrometeorological Branch (U.S. Weather Bureau 1961, 1969, National Weather Service 1975) have shown the all-season PMP occurring in August and September. We consider this a realistic latitudinal trend.

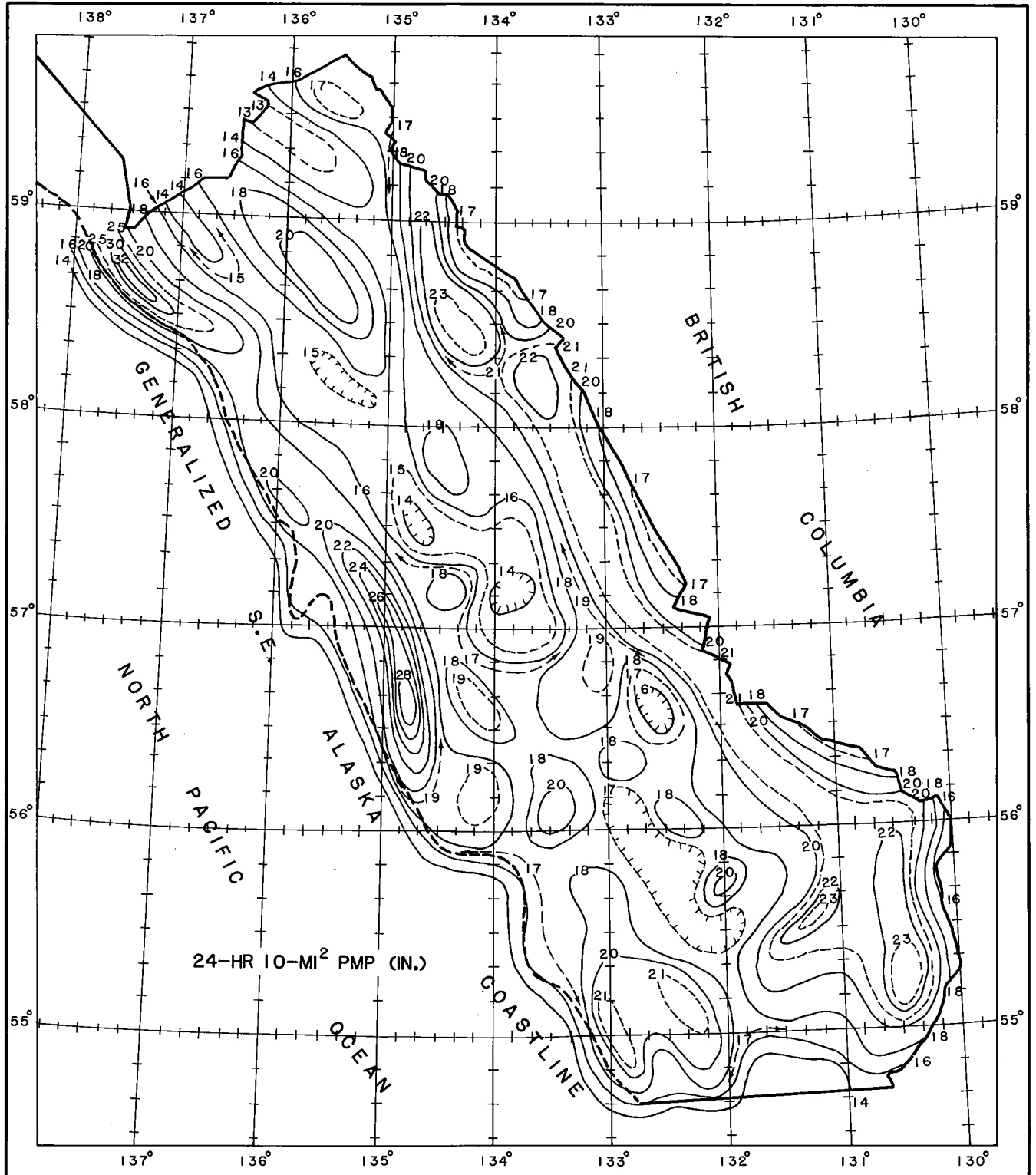

Figure 27.—24-hr 10-mi² (26-km²) PMP (in.) for Southeast Alaska.

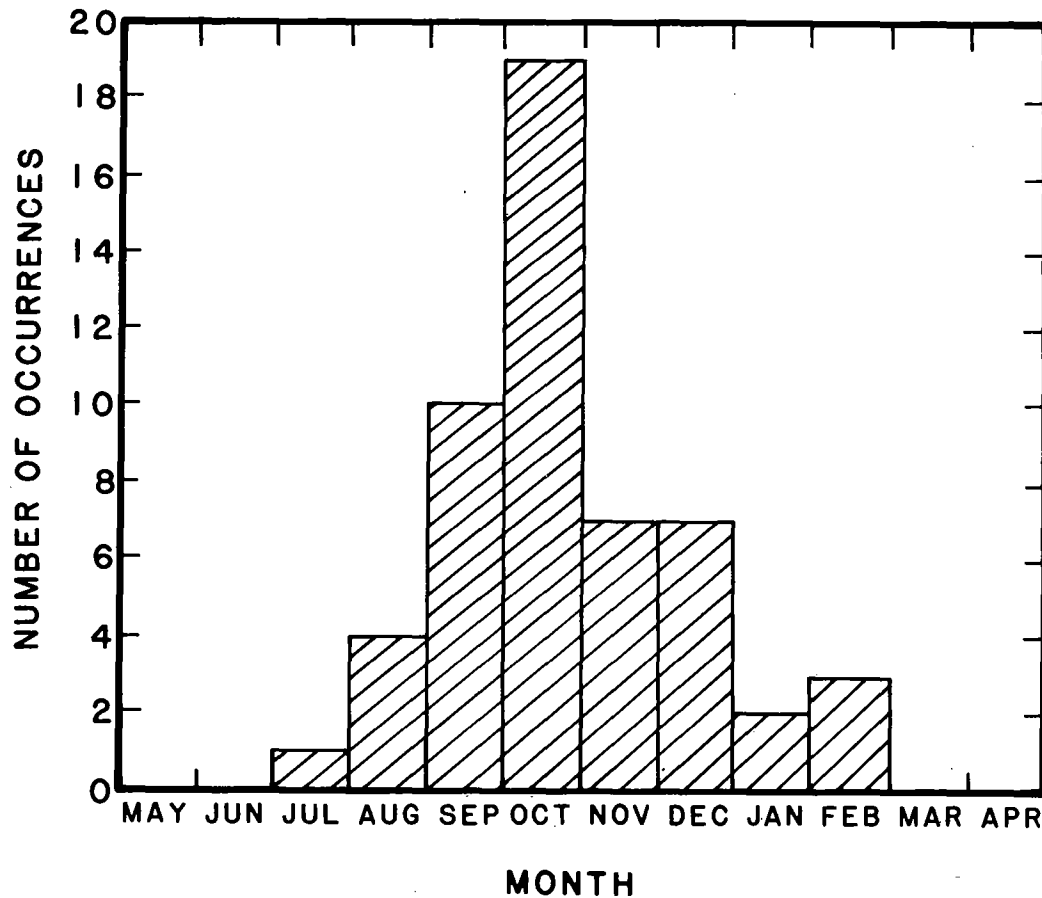

Figure 28.—Histogram of month of occurrence of maximum daily precipitation.

3.7.2 Conclusion

The adopted seasonal variation relation for southeast Alaska of figure 29 results in the seasonal variation percentages shown in table 16. We recommend interpolating appropriate percentages from table 16 to apply to the all-season PMP to obtain PMP for combination with snowmelt.

Table 16.—Seasonal variation in percent of October 1 probable maximum precipitation

Date	PMP (percent of October 1)	Date	PMP (percent of October 1)
October 1	100	September 15	99
September 1	98	August 15	96
August 1	92	July 15	87
July 1	80	June 15	72
June 1	70	May 15	70
May 1	73	April 15	79

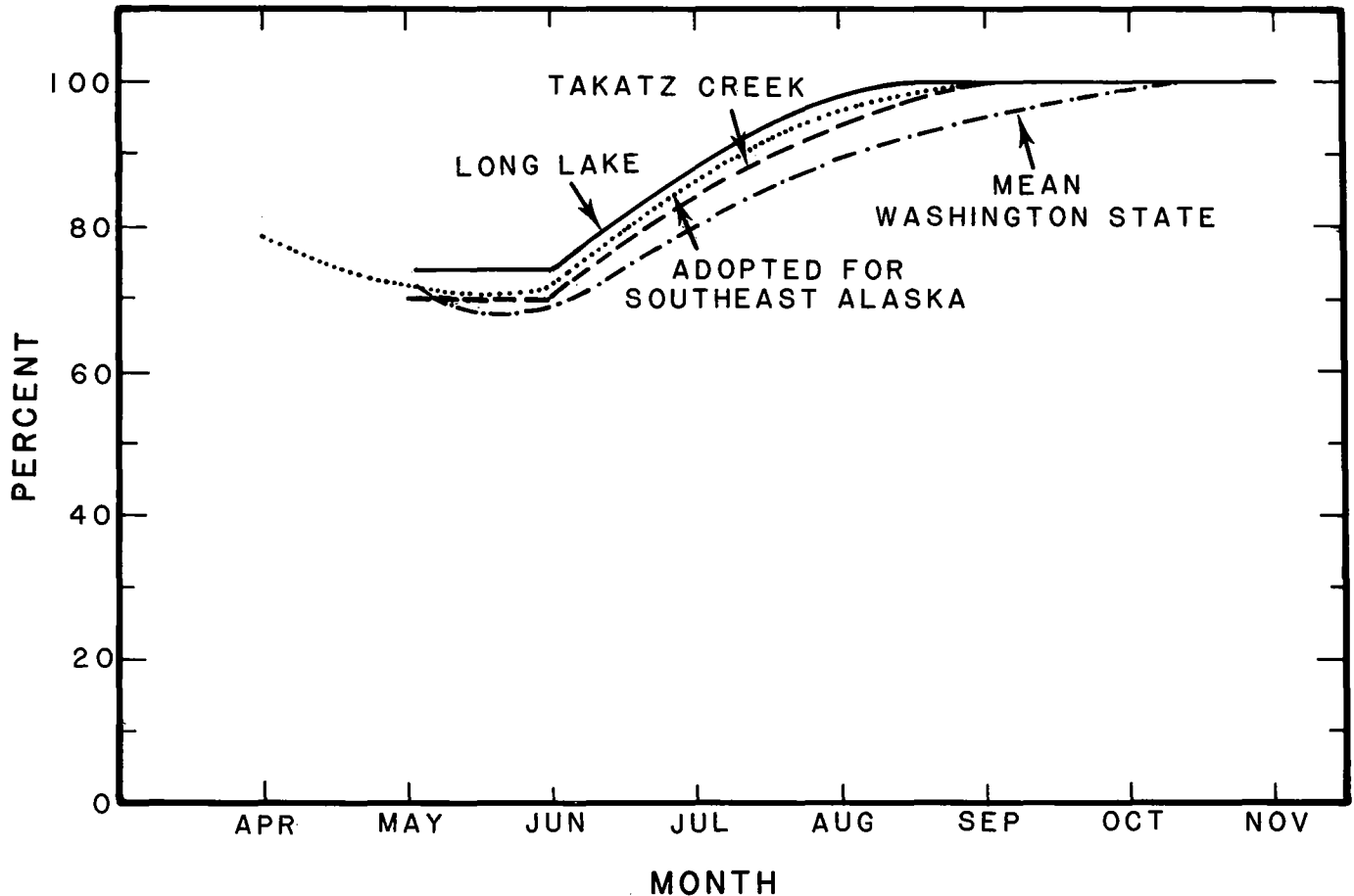

Figure 29.—Seasonal variation of probable maximum precipitation for southeast Alaska. (See fig. 5 for location of Long Lake and Takatz Creek.)

3.8—Depth-Area-Duration Relations for Southeast Alaska Probable Maximum Precipitation

The basic PMP chart (fig. 27) for southeast Alaska is for 24 hr 10 mi^2 (26 km^2). Depth-area-duration (DAD) relations are presented for areas to 400 mi^2 ($1,036 \text{ km}^2$) and durations to 72 hr. Since the 24-hr, 10-mi^2 (26-km^2) value is the basic value, all DAD values are given in percent of the 24-hr, 10-mi^2 (26-km^2) values.

3.8.1 Depth-Area-Duration Relations to 24 hours

Figure 2.16 of Technical Paper No. 47 (Miller, 1963) gives depth-area percentages for PMP to 400 mi^2 ($1,036 \text{ km}^2$) for durations of 6, 9, 12, 18 and 24 hours. This provides the basis for developing depth-area relations for durations to 24 hours for southeast Alaska PMP. In order to move from the depth-area relations (Miller 1963) to a set of DAD relations to 24 hours for the southeast portion of Alaska, the following are considered.

A 6- to 24-hr ratio of about 0.50 is characteristic for total PMP along the west coast of the contiguous United States. The similarity of the PMP storm type

across latitude supports such similarity of ratios from the states of California to Washington. A comparable maritime climatic regime for storm situations prevails in southeast Alaska and along the south coast of Alaska. The adopted 6- to 24-hr ratio for the Bradley Lake PMP estimate (U.S. Weather Bureau 1961) was just under 0.50 while most previously made individual estimates for southeast Alaska basins have had adopted 6- to 24-hr ratios near or slightly over 0.50. Since the orographic component of the total PMP has ratios well below 0.50, one should expect the total PMP 6- to 24-hr ratio to drop a little below 0.50 for those basins where the orographic component makes up a large portion of the total PMP. A summary of maximum 24-hr rains at Annette and Juneau led to an overall average 6- to 24-hr ratio of about 0.40. Our depth-area and depth-duration ratios apply to an index of total PMP in southeast Alaska. Thus, we have adopted a 6- to 24-hr ratio of 0.50 as a good overall value for this area.

A smooth depth-duration relation making use of the adopted 6- to 24-hr ratio of 0.50 is provided by figure 2.14 in Technical Paper No. 47. The information in this figure is used to obtain ratios appropriate for 10 mi² (26 km²) for discrete durations to 24 hours.

Combining the above depth-area and depth-duration ratios gives us an array of depth-area-duration ratios (with the 24-hr, 10-mi² (26-km²) ratio equal to 100 percent, or, 1.0) as shown in table 17.

Table 17.--Depth-area-duration relations to 24 hrs and 400 mi² (1,036 km²) in percent of the 24-hr 10-mi² (26 km²) probable maximum precipitation

Duration (hrs)	Area mi ² (km ²)			
	10 (26)	100 (259)	200 (518)	400 (1036)
6	.50	.46	.43	.40
9	.63	.58	.55	.51
12	.74	.74	.66	.62
18	.89	.84	.80	.76
24	1.00	.94	.91	.87

3.8.2 Extension of Relations to 72 hours

For the present study, it was necessary to provide PMP estimates for durations between 24 and 72 hours. This required expansion of the previously developed depth-area-duration ratios to provide estimates for the longer durations.

3.8.2.1 Adopted 3- to 1-day Ratio for 10-mi² (26-km²) Rainfall. A first step in determining an appropriate 3- to 1-day ratio was the examination of large observed 1-day rains. The rainiest observing station in southeast Alaska is Little Port Walter. A plot of 36 cases of 72- to 24-hr rainfall ratios for Little Port Walter 1-day rains of 6 in. (152 mm) or more showed that the ratios tend to converge toward 1.60*. Since the selection was made on the basis of maximum 1-day rains, the resulting ratio (i.e., 1.60) should be considered on the low side since the denominator of the ratio was emphasized. That is, a selection of a comparable number of cases based upon maximum 3-day rains would tend to result in a higher ratio.

*The mean ratio for the 36 cases was 1.59.

A second source for developing 72- to 24-hr ratios involved depth-duration summaries of average ratios for statistical return period estimates of 100-yr 1- and 3-day values from Technical Paper No. 47 (Miller, 1963) and Technical Paper No. 52 (Miller, 1965). For a summation of ratios for 100-yr return period rains, Alaska was divided into a maritime zone (southeast Alaska and the south coast), the interior, and intermediate transition zone. For the maritime region, which includes our study area, the average 72- to 24-hr ratio was 1.75.

Earlier PMP estimates made for southeast Alaska provide a third source for estimating 72- to 24-hr ratios. A PMP estimate for southeast Alaska for Takatz Creek (Riedel, 1967) was based upon a detailed study that included computations using a laminar flow orographic model. For this "control" basin the 72- to 24-hr ratio of 1.70 for 10 mi² (26 km²) is appropriate for our region.

3.8.2.2 Extension of Depth-Duration Ratios to Other Area Sizes. Using the 1.70 for our adopted 72- to 24-hour ratio and values from table 17 for durations of less than 24 hrs at an area of 10 mi² (26 km²), a smooth depth-duration curve was constructed. Values for durations of 36, 48, and 60 hrs were interpolated from this curve. An extrapolated depth-area curve for 72 hrs was then constructed to 400 mi² (1,036 km²) paralleling the curve for 24 hrs. Curves for the intermediate durations were then interpolated between these two curves using the previously determined 10-mi² values as starting points.

Although these sources are not completely independent, each has examined the data from a different perspective. The ratios obtained from these different approaches vary between 1.65 and 1.75. Figure 30 shows the adopted set of DAD values, with the 24-hr, 10-mi² (26-km²) value equal to 100 percent.

3.8.3 Procedure for Use of Basic Depth-Area-Duration Values

PMP values for a basin are determined and used as follows:

- a. First determine the average PMP for 24 hr and 10 mi² (26 km²) by averaging the values read for a basin from figure 27.
- b. Read the ratios at the area of basin from figure 30.
- c. Multiply values in step a. by ratios obtained in step b. to get accumulative PMP values for the basin area for the appropriate durations.
- d. Plot a depth-duration curve from values in step c. and read accumulative depth-duration values for all desired durations.
- e. Subtract successive values in step d. to obtain incremental values.

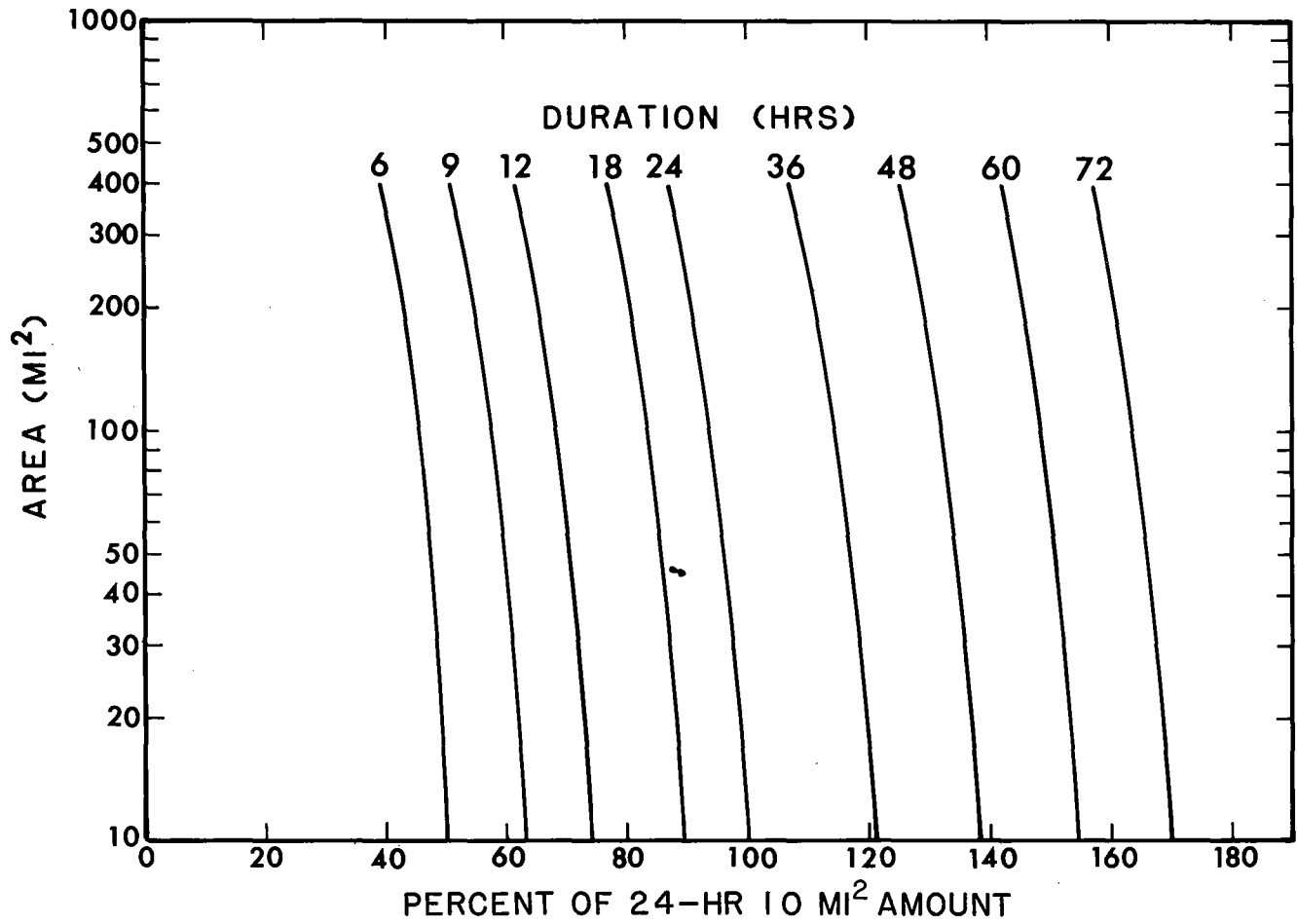

Figure 30.—Depth-area-duration relation for southeast Alaska probable maximum precipitation.

- f. Arrange the values from step e. in any sequence that may be hydrologically critical so as not to undercut PMP values for any duration.
- g. Determine percent reduction from table 16 if other than all-season PMP is required.

3.8.4 Areal Distribution of Probable Maximum Precipitation

In general, uniform distribution of PMP is suggested for PMP over basins in southeast Alaska. However, where fixed significant control by orography exists, we recommend that the user distribute the PMP in line with such orographic control. As a yardstick for judgment on whether orographic controls are significant, we suggest that, if 24-hr 10-mi² (26-km²) PMP varies by as much as 25 percent within the boundaries of a basin, the user should consider orographic control as significant and determine the areal distribution of isohyetal values within the basin.

If orographic control is significant on the areal distribution of PMP in the basin, the "first approximation" distribution should be accomplished as follows:

1. The average 24-hr, 10-mi² (26-km²) PMP is determined for the basin. This average value is assigned 100 percent.
2. A set of analyzed 24-hr, 10-mi² (26-km²) lines across the basin are then labeled in percents on the basis of the mean value (from step 1) being the 100-percent value.
3. The percent lines of step 2 need to be relabeled to give the basin average PMP. This is done by assigning the basin average PMP, in inches, to be the 100 percent line of step 2 and assigning values in inches to the remaining lines from products of the percentages by the basin mean PMP (in inches). These values are now orographically controlled labels of 24-hr basin PMP.
4. From step 3, incremental percents for obtaining labels for any desired increments of PMP are obtained by reading appropriate ratios from figure 30 at the area of the basin, constructing a smooth depth-duration curve if necessary, to obtain all desired ratios, and obtaining incremental values from accumulative percents. Appropriate percents are then applied to the labels in step 3 to obtain incremental labels.

In the procedure just outlined, the user may obtain a result that produces an unacceptable depth-area relation. Using the 6-hr labels as a test, a depth-area curve should be constructed, converted to a percentage depth-area curve, and compared with the PMP depth-area curve for figure 30. If the resulting depth-area curve, when tied into the PMP curve at the basin area, results in any values for smaller areas exceeding the PMP values, the user must then make some "trial and error" downward adjustment in the values in previous steps until exceedance of PMP at areas smaller than the basin are avoided. However, adopted values for areas smaller than the total basin area may be a modest amount below the PMP amounts for these smaller areas. Any required adjustments at the 6-hr duration may then be applied to other durations to assure consistency throughout all durations.

4. GENERALIZED SNOWMELT CRITERIA

4.1 Introduction

This chapter provides generalized criteria for determining snowmelt based upon varying placements of the 3-day PMP. These criteria include temperatures, dew points, wind and snowpack, along with elevation variations of each element. We first give brief background support for each of the separate criteria. Then, the necessary generalized charts and schematics are presented along with a stepwise

procedure for obtaining the necessary estimate of values of each element for a basin. For clarification to the user, an example of the determination of snowmelt criteria is presented.

This generalized approach may smooth over differences in particular regions that the user knows exist and wishes to retain. For example, the generalized elevation contours of figure 5 may oversimplify the topography in many basins for snowmelt computations. In such cases, the user may use more detailed topographic maps in obtaining values of the various snowmelt parameters. Also, in certain areas, such as around Ketchikan and Juneau where more information than in general is available on MAP variations, the user, instead of using data from the generalized MAP chart (fig. 6) may judiciously make use of more detailed MAP variations that he confidently feels are warranted.

4.2 Temperature Criteria

Temperature criteria are provided for the 3-day PMP storm and for a period of 5 or more days prior to the PMP event. In line with prior precedent from previous studies (U.S. Weather Bureau, 1961, 1966, 1967, National Weather Service 1977) dealing with Alaskan snowmelt criteria, two sets of criteria are developed. One is the high-temperature sequence; the other, the high-dew-point sequence. The first is tied to a synoptic event where high pressure and clear skies (continental influence) predominate. This high-temperature sequence used prior to 3-day PMP has a large temperature-dew point spread. The other (the high-dew-point sequence) is derived from a maritime regime of onshore flow. This regime gives less extreme temperatures (i.e., more cloudiness, less sunshine) but higher dew points than does the high-temperature sequence. Somewhat different elevation variations are given for the two contrasting temperature sequence types (sec. 4.2.2.4).

4.2.1 Temperature Criteria During the 3-Day Probable Maximum Precipitation

During the 3-day PMP storm, saturated conditions are assumed in the sense that mean daily temperatures and dew points are the same. Therefore, during the 3-day PMP the adopted temperatures come directly from the dew points that are the maximum 12-hr persisting dew points for the season and location. (See dew-point criteria, sec. 4.3.)

4.2.2 Temperature Criteria Prior to 3-Day Probable Maximum Precipitation

Temperature criteria for snowmelt prior to PMP require:

- a. Mean midmonthly temperature charts.
- b. A sequence of daily temperature departures for up to 5 or more days prior to PMP for the high-temperature case.
- c. A sequence of daily temperature departures for up to 5 or more days prior to PMP for the high-dew-point case.
- d. Elevation variations of temperature criteria for both categories b. and c.

4.2.2.1 Mean Temperature Charts Figure 31 shows analyzed midmonth temperature charts for March through June. The primary data used for these analyses were 30-yr normal monthly temperatures (1941-70) for nine stations in southeast Alaska (Environmental Data and Information Service, 1973). We attempted to obtain a reasonable consistency in changing orientation as the offshore warm source in April changed to an onshore (inland) warm source in June with May the primary transitional month. The March map (fig. 31) shows an important characteristic for the months of snowpack accumulation - that is colder temperatures inland away from the coast.

4.2.2.2 High-Temperature Case Departures A consideration of extreme temperature departures for south coast and southeast Alaska locations resulted in the conclusion that the basic synoptic type for the highest temperatures is the same as previously determined for the Alaskan Interior Region (U.S. Weather Bureau, 1966). This consists of large-scale domination by high pressure with relatively light winds, above normal sunshine, high temperature, and relatively low humidities.

Numerous high-temperature sequences at southeast Alaskan stations were summarized with tie-ins with previous specific estimates of Alaskan snowmelt criteria for the south coast and other locations. The following are to be noted:

- a. Of the five warmest Aprils at Annette and Juneau, 1953 was the warmest April for Annette and the second warmest April for Juneau, while 1960 was the third warmest April at both locations.
- b. Warm Mays that also were warm along the south coast of Alaska were those of 1953 and 1960, while similar warm Junes were those of 1953 and 1958. The number of cases, especially in May and June, where southeast Alaska is warm during the same periods that the south coast is warm supports previous conclusions on similar synoptic types as previous Alaskan basin estimates.
- c. May 1960's temperatures at Juneau show how high temperatures typical for a number of days prior to rain (due to the high-pressure, continental-type weather control) gradually give way to a maritime rain-producing regime. An abrupt change of prevailing type is unrealistic. Other southeast Alaska warm spells also confirmed prior conclusions on continental influences for the warmest temperature cases.

Departures in temperatures for increasing durations were determined from many months comprised of unusual warm spells. The adopted criteria for the warm temperature cases come from the summation of departures from unusual warm spells such as those shown in table 18. For this study for the high-temperature sequence, we have adopted a value of +6°F (3.3°C) above normal for the first 3 days prior to PMP, +7.5°F (4.2°C) for the 4th day, and +12.5°F (6.9°C) for the 5th day and +10°F (5.6°C) above normal for the 6th through 10th days. This gives a 10-day average departure of about +9°F (5°C).

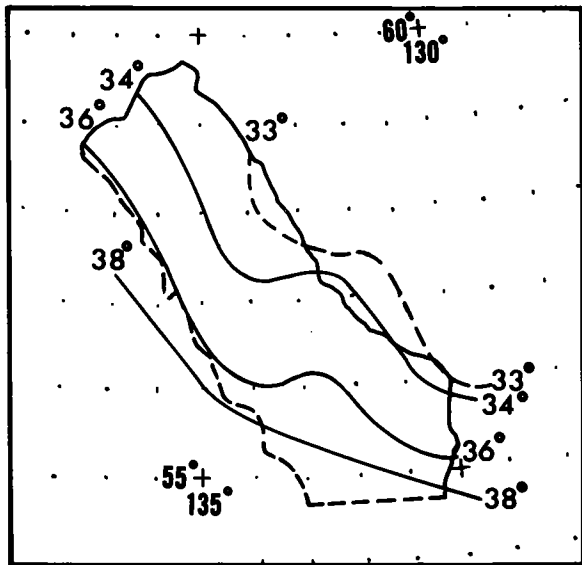

MID-MARCH

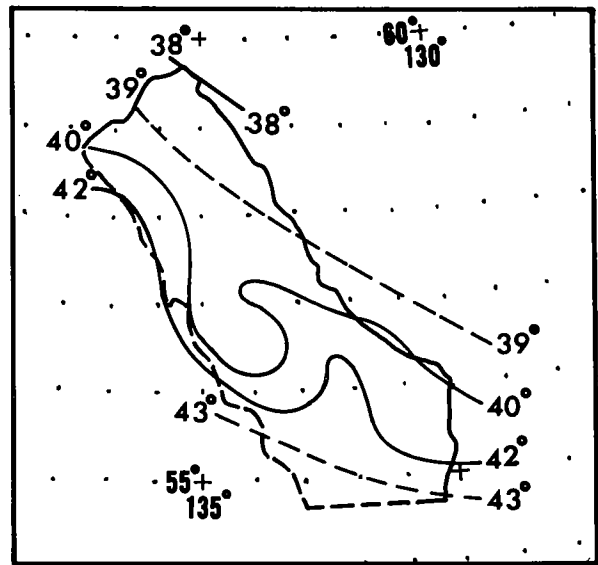

MID-APRIL

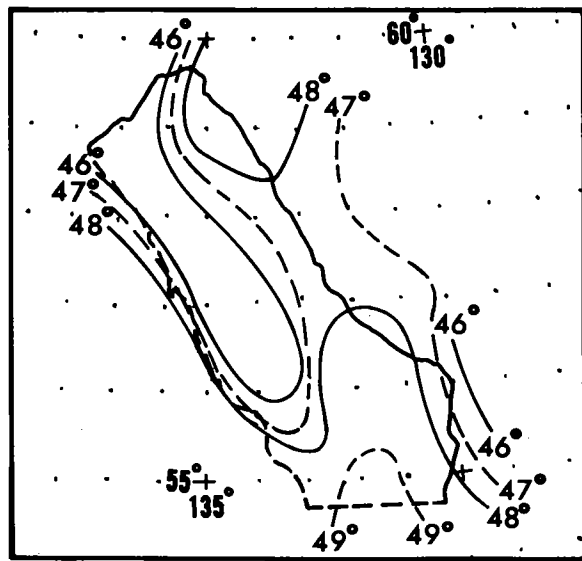

MID-MAY

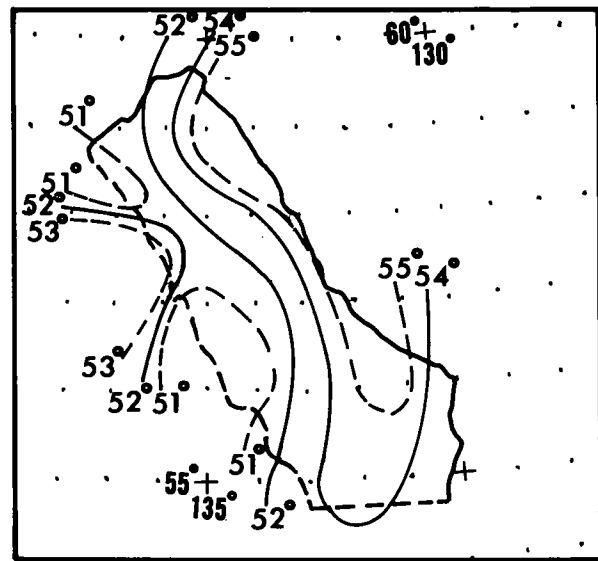

MID-JUNE

Figure 31.—Mean sea-level temperature (°F) for study area mid-March to mid-June

Table 18.—Summation of temperature departures (°F) from unusual warm spells

Station	Date	Day prior to maximum temperature										Highest daily temp. (°F)
		1	2	3	4	5	6	7	8	9	10	
Ketchikan	5/10-12/42	13*	11	10	-	-	-	-	-	-	-	61
Ketchikan	5/18-27/58	16	14	12	10	10	10	10	10	8	8	68
Ketchikan	5/28-6/7/56	12	12	11	9	9	10	9	8	8	9	66
Annette	4/21-30/58	12	11	11	11	11	11	10	10	10	9	57
Annette	4/1-6/58	14	13	11	9	8	9	-	-	-	-	54

*All values are rounded off to nearest whole degree F. To convert to °C use equation $C = \frac{5}{9} (F - 32)$

A plot was made of many cases where a 1-day temperature departure of 10°F (5.6°C) or more comprised a sequence of positive temperature departures. The mean relation and envelopes of the data are shown in figure 32. From this figure, support can be seen for a generalization that allows for some lessening of the temperature departures for several days following the day of most extreme departure. Synoptically, such a trend is realistic as one goes from the large temperature departures toward a rainy spell which we must postulate for tying into any above-normal temperature sequence with the 3-day PMP.

4.2.2.3 High Dew-point Case Departures. A survey of high-dew-point cases indicated a rather firm tendency for decrease in the magnitude of the positive temperature departures for the high-dew-point cases when compared to the high-temperature cases. This confirmed prior work done with temperature and dew-point data from the south coast region for earlier specific Alaskan basin estimates. These data are significant in adopting temperature criteria for high-dew-point situations, since the adopted criteria is to be used prior to the occurrence of 3-day PMP. Thus, for this study for the high-dew-point case, the temperature departure we adopt for the first 3 days prior to the 3-day PMP is held to +2°F (1.1°C) for each day, increasing to +3°F (1.7°C) the 4th day prior to the beginning of the PMP and to +5°F (2.8°C) for 5 to 10 days prior to PMP (see fig. 33).

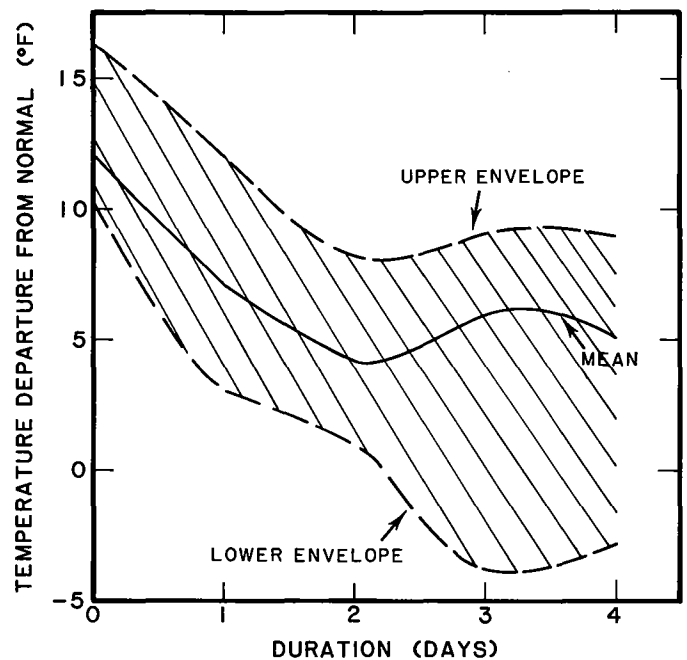

Figure 32.—Temperature departures in relation to peak daily temperatures.

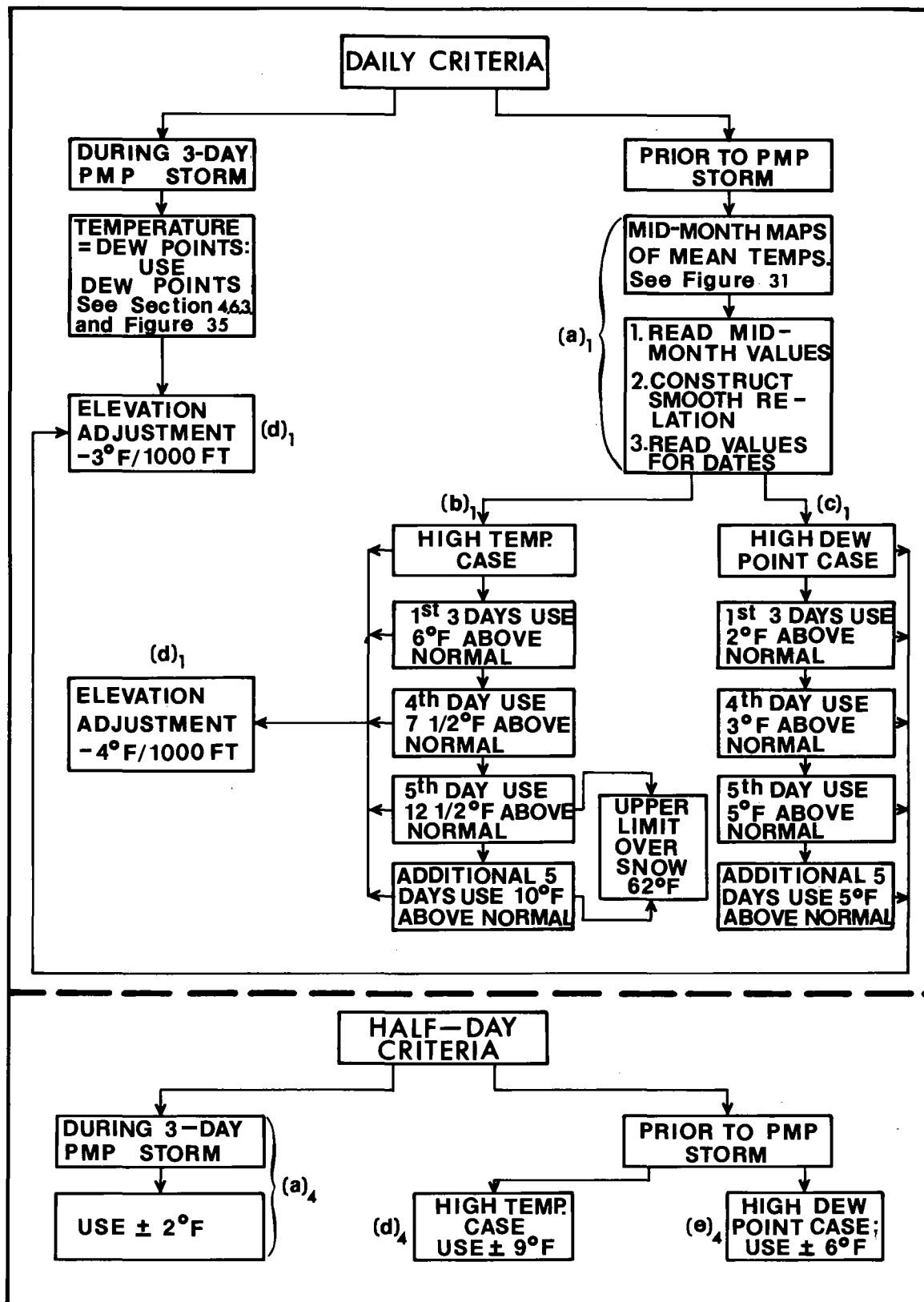

Figure 33.—Schematic for snowmelt temperature criteria.

4.2.2.4 Elevation Variations. In a generalized PMP and snowmelt study for the Yukon (U.S. Weather Bureau, 1966), a study of upper-air soundings for high-temperature situations led to the adoption of a criteria of $-4^{\circ}\text{F}/1,000\text{ ft}$ ($-2.2^{\circ}\text{C}/305\text{ m}$) for such situations. Thus, for the high-temperature case, we adopted a lapse rate of $-4^{\circ}\text{F}/1,000\text{ ft}$. ($-2.2^{\circ}\text{C}/305\text{ m}$). This contrasts to a vertical lapse rate of $-3^{\circ}\text{F}/1,000\text{ ft}$ ($-1.7^{\circ}\text{C}/305\text{ m}$) for the saturated 3-day PMP period.

Earlier specific PMP studies for the south and southeast coasts of Alaska helped firm up the adoption for this study of a lapse rate of $-3^{\circ}\text{F}/1,000\text{ ft}$ ($-1.7^{\circ}\text{C}/305\text{ m}$) for the high-dew-point snowmelt case. Additional checks on lapse rates in southeast Alaska situations done for this generalized study supported the reasonableness of these separate criteria for vertical lapse rates in the maritime vs. the continental broadscale weather types.

4.2.3 Upper Limit of Mean Daily Temperature Over Snow Cover

In the Yukon study (U.S. Weather Bureau, 1966) an upper limit to mean daily temperature over snow cover of 62°F (16.7°C) was determined to be realistic. This same limit is adopted for our study area. Therefore, wherever the application of temperature criteria results in a mean daily temperature above 62°F (16.7°C) the temperature(s) should be reduced to the maximum allowable daily mean temperature over snow cover of 62°F (16.7°C).

4.2.4 Half-Day Temperature Criteria

The user may wish to divide daily criteria into half-day criteria. We recommend the following half-day temperature criteria:

1. During the 3-day PMP event, use $\pm 2^{\circ}\text{F}$ (1.1°C).
2. Prior to the 3-day PMP event with high-dew-point case, use $\pm 6^{\circ}\text{F}$ (3.3°C).
3. Prior to the 3-day PMP event with high-temperature case, use $\pm 9^{\circ}\text{F}$ (5.0°C).

Some of the support for the adopted half-day criteria comes from prior studies done in Alaska. Furthermore, as part of the present study additional summations of high-dew-point and high-temperature cases support the adopted spectrum of half-day values. For example:

- a. For a May 18-27, 1958, warm period at Annette, the diurnal range in temperature was 18°F (10.0°C). For a warm spell, April 21-30, 1931, the range in temperature averaged 24°F (13.3°C).
- b. For May and June cases of high-dew-point situations at Annette accompanied by 24-hr precipitation of 2 in. (50.8 mm) or more, an approximate 12°F (6.7°C) range in temperatures was suggested.
- c. An average of the difference between maximum and minimum temperatures for warm months for northern,

central, and southern portions of southeast Alaska did not show any need for regional differences. Hence, the same high-low spreads (or 1/2-day breakdowns of mean daily temperature) were adopted for all of southeast Alaska covered in the present study.

4.2.5 Schematic of Temperature Criteria

A schematic (fig. 33) was made showing the basic snowmelt temperature criteria discussed in previous sections. This schematic, together with the required figures, provides a stepwise method of obtaining temperature criteria for snowmelt for any basin in southeast Alaska. Letters in parentheses refer to steps discussed in section 4.6.

4.3 Dew-Point Criteria

As in the generalized snowmelt temperature criteria (sec. 4.2), two sequences are needed for the dew-point criteria in addition to the dew-point sequence during the PMP storm. One sequence concerns the dew points that go with the high-temperature case; the other sequence concerns the dew points that go with the high-dew-point case. The dew-point criteria for both the high-temperature and the high-dew-point sequences are developed in the form of increments (in °F) to subtract from the respective temperature criteria, determined from the use of the schematic of figure 33 and other necessary figures.

4.3.1 Dew-Point Criteria During the 3-Day Probable Maximum Precipitation

Basic dew-point criteria are needed for the 3-day PMP. As pointed out in section 4.2.1, the daily temperature criteria for the 3-day PMP are defined by the basic daily dew-point criteria since saturation is assumed. For the purpose of obtaining dew points (and, therefore, temperatures) during the 3-day PMP, a series of dew-point charts was developed (fig. 34). The monthly dew-point charts were derived from the following:

- a. 12-hr persisting dew-point charts for Alaska by months developed originally for the Yukon Project (U.S. Weather Bureau 1966).
- b. Updating of the dew-point charts referred to in a. (for the portion of the year needed in this report) from smoothed seasonal adjustments based upon a precipitable-water analysis for Alaskan stations (Lott 1976).
- c. The relation of 12-hr to daily dew points and the variation of daily dew points within the 3-day PMP comes from previously adopted durational variation of dew points for Alaska.

In order to obtain the appropriate maximum 24-hr dew-point for a specific placement of the PMP, the user reads a sufficient number of midmonth maximum 24-hr dew points based upon the chosen date for placement of the 3-day PMP. For the second day subtract 2°F (1.1°C) from the maximum value, and for the third day subtract 4°F (2.2°C).

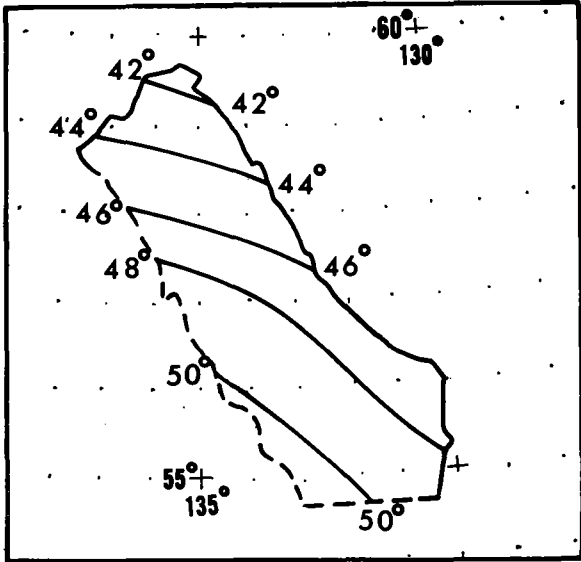

MID-MARCH

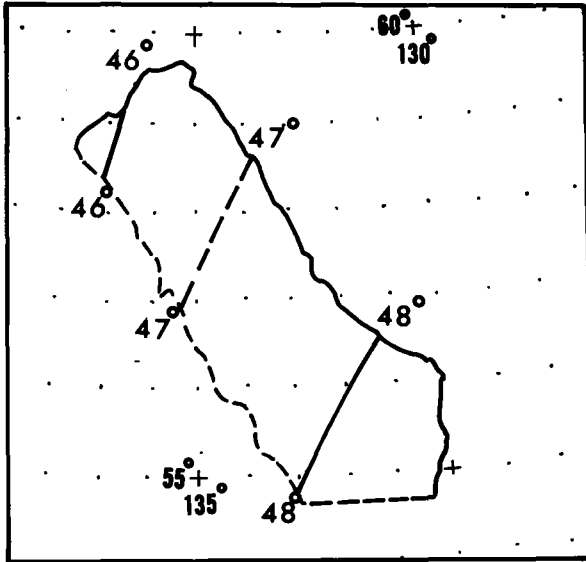

MID-APRIL

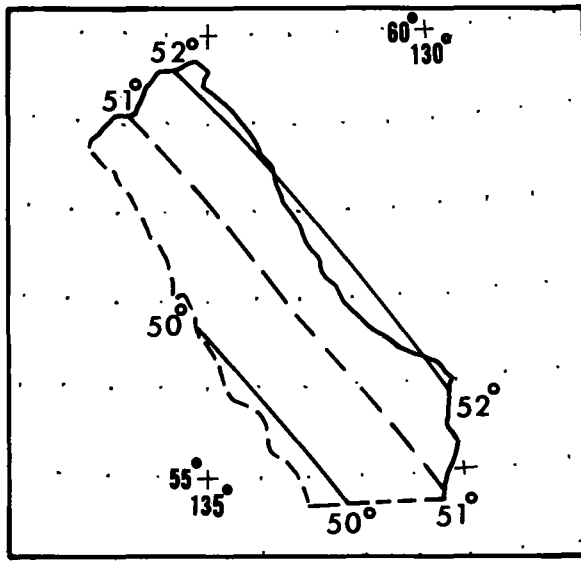

MID-MAY

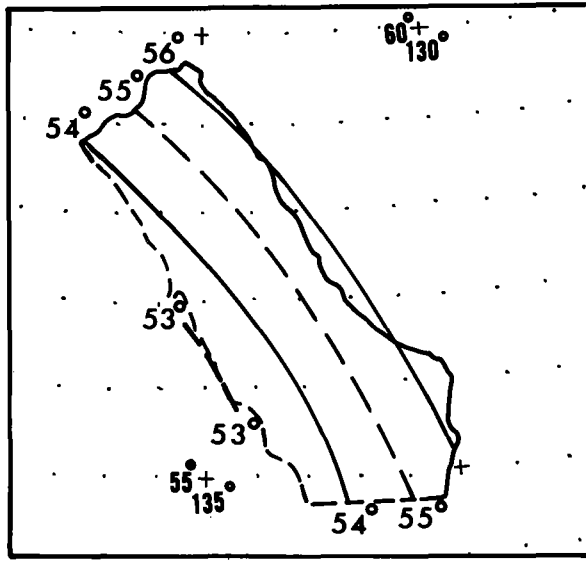

MID-JUNE

Figure 34.—24-hr sea-level dew point (°F) for study area mid-March to mid-June.

4.3.2 Dew-Point Criteria for High-Temperature Sequence Prior to 3-Day Probable Maximum Precipitation

Dew-point criteria to go with the prior-to-3-day PMP high-temperature sequence are developed by means of temperature-dew-point spreads defined by high-pressure dominated, high-insolation, low-wind situations that produce the high-temperature sequence. The offshore flow characteristic of these situations results in relatively low humidities, or large temperature-dew-point spreads. The adopted temperature-dew-point spread for the high-temperature sequence is 13°F (7.2°C) for the first 3 days, increasing to 18°F (10°C) for days prior to this (see fig. 35). The 18°F (10°C) spread is continued out to the 10th day before the beginning of the 3-day PMP, if criteria are needed for this many days.

A typical example in support of the adopted dew-point criteria is for May 1942. During May 1942, the temperature at Juneau averaged 5.2°F (2.9°C) above normal with the warmth concentrating in the last two-thirds of the month when only 0.84 in. (21 mm) of precipitation occurred. Of 16 days on which the dew point was $\geq 40^\circ\text{F}$ (4.4°C), 12 were consecutive. For the 16 days, the average temperature-dew-point spread was 10°F (5.6°C) while on 8 days the high-low temperature spread was $\geq 18^\circ\text{F}$ (10°C).

4.3.3 Dew-point Criteria for High-Dew-Point Sequences Prior to 3-Day Probable Maximum Precipitation

In generalizing the temperature-dew-point spread for the high-dew-point case, high-dew-point situations at Annette were investigated for days in May and June. These suggested an average temperature-dew-point spread of 5°F (2.8°C) for a short sequence. The adopted criteria were 4°F (2.2°C) for the first 3 days prior to PMP, 6°F (3.3°C) for the fourth day, and 8°F (4.4°C) for the fifth day or more prior to the PMP (fig. 35).

4.3.4 Elevation Variation of Dew Points

The adopted separate temperature elevation variations discussed in section 4.2.2.4 also apply to the separate dew-point criteria -- that is, a -4°F (-2.2°C) per 1,000-ft (305-m) lapse rate for the dew points that go with the high-temperature criteria and -3°F (-1.7°C) per 1,000 ft (305 m) for the dew points that go with the high-dew-point criteria.

4.3.5 Upper limit

If, in accordance with section 4.2.3, a daily temperature must be reduced from a higher value to 62°F (16.7°C), then the same reduction should be applied to the accompanying dew point also. This would ensure that the adopted temperature-dew-point spread is retained.

4.3.6 Half-day dew-point criteria

The following half-day dew-point criteria are recommended:

1. During the 3-day PMP event, use $\pm 2^\circ\text{F}$ (1.1°C).
2. Prior to the 3-day PMP event with high-temperature case, use $\pm 3^\circ\text{F}$ (1.7°C).

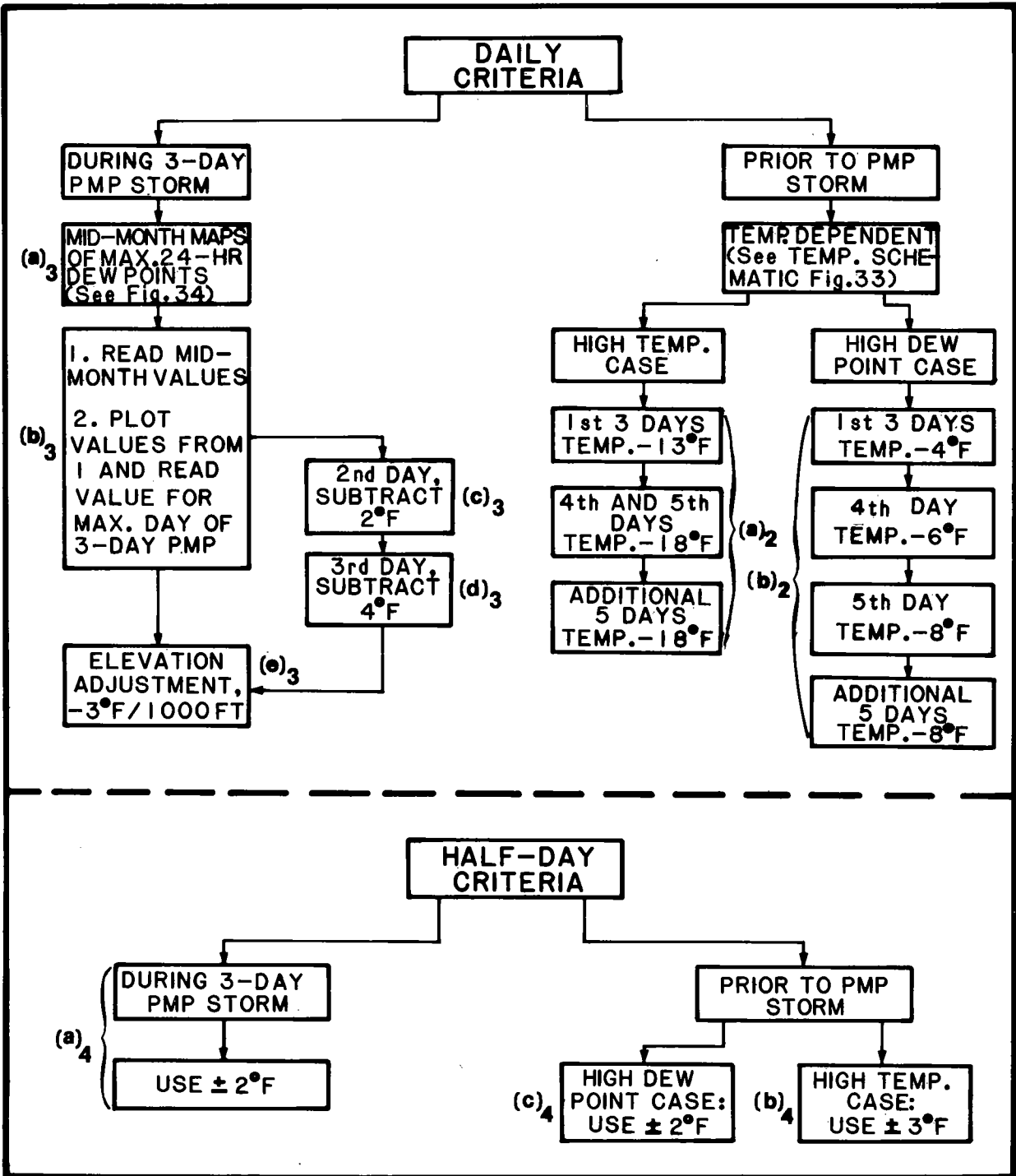

Figure 35.—Schematic for snowmelt dew-point criteria.

3. Prior to the 3-day PMP event with high-dew-point case, use $+2^{\circ}\text{F}$ (1.1°C).

4.3.7 Schematic of Snowmelt Dew-Point Criteria

A schematic in condensed form giving all the basic snowmelt dew-point criteria just discussed, is shown in figure 35. This schematic, in conjunction with the schematic of figure 33 and other required figures, constitutes a stepwise procedure for obtaining the necessary dew-point criteria for snowmelt.

4.4 Wind Criteria

Wind criteria, in addition to being necessary for snowmelt computations during the 3-day PMP, are also needed for prior-to-PMP snowmelt for the two types of prevailing temperature regimes (high-temperature and high-dew-point) that are possible prior to the 3-day PMP. Seasonal variation and elevation factors are also needed and developed for the wind criteria.

4.4.1 Wind Criteria During the 3-Day Probable Maximum Precipitation

Wind criteria during a 3-day PMP storm have evolved for use in southeast Alaskan basins from specific Alaskan basin studies over a period of years. An extensive summary of winds aloft, including barrier effects, was done in connection with the PMP estimate for Bradley Lake, Alaska (U.S. Weather Bureau 1961). From data used in this estimate, which included wind data from southeast Alaska and additional work involving seasonal variation for winds from southeast Alaska to the northwest coast of the United States, we adopt April daily sea-level wind criteria for the study area for the 3-day PMP of 36, 28, and 25 mph (16.1, 12.5, and 11.2 m/s), respectively. These values have been reduced 25 percent from the originally higher free-air wind values to allow for surface effects. This 25-percent reduction includes allowance for occurrence over snow cover, in addition to an adopted slight reduction for generalizing southward along the coast, thereby providing a consistent trend to tie into the lower magnitude PMP winds used in the Northwest PMP Report (U.S. Weather Bureau, 1966).

4.4.1.1 Seasonal Variation Factors. Seasonal variation factors with April set equal to 100 percent were adopted from generalizations of surface and upper-air wind surveys for south and southeast Alaska points used in earlier PMP computations (U.S. Weather Bureau 1961). With April winds equal to 100 percent, May is 92 percent, while both June and July (where data indicated insignificant differences) are 83 percent.

4.4.1.2 Barrier Adjustments. The complicated terrain features in southeast Alaska have unusual effects upon the wind. We cannot hope to unravel for generalizing purposes the detailed, complicated nature of such effects. However, on a generalized basis, we know that as multiplication of barriers increase inland, an overall average decrease of the wind must take place in low levels. Some clues to these "sheltering effects" for a particular south coast area (i.e., Bradley Lake) were developed in an earlier PMP study (U.S. Weather Bureau 1961). For southeast Alaska we generalize by adopting a modest reduction in wind of 5 percent per 1,000-foot barrier. The method of obtaining the barrier involves a compensating factor in application to snowmelt computations in that maxima rather than mean elevations are used along a particular inflow direction.

The generalized elevation chart (fig. 5) is the basic chart for barrier determination for adjusting the "no-barrier" sea-level winds. We intend to provide reasonable overall barrier estimates for basins in southeast Alaska where very complicated terrain separated by bodies of water is characteristic. To obtain the barrier for a specific basin, the following steps are required:

1. Draw straight lines from the center of a basin to the coast beginning at 256° and continuing with additional lines at 27° angular increments counterclockwise to 148° (256°, 229°, 202°, 175°, and 148°). This provides line segments (each representing a 27° sector) so that the directions of the inflow (from regions of warmer waters) from 270° (west) counterclockwise to 135° (southeast) are sampled.
2. Determine the maximum generalized elevation each segment passes across from the basin to the coast for each segment in step 1 that reaches water (only segments that reach water represent a moisture inflow direction). Ignore segments that do not reach water.
3. Determine a mean of values of barrier height along each applicable segment (i.e., toward a moisture source) in 2. This computed mean is the barrier to that basin. An adjustment of -5 percent per 1,000 ft (305 m) is applied to the no-barrier winds, based upon the computed barrier height. This adjustment applies to all elevations.

4.4.1.3 Elevation Variation of Wind During Probable Maximum Precipitation. The adopted variation of wind with height during the 3-day PMP is shown in table 19 and also on the schematic for snowmelt wind criteria (fig. 36). If the user needs winds for elevations higher than 7,000 ft (2,134 m), the trend of 10-mph (4.5-m/s) increase per 1,000 ft (305 m) may be continued.

Table 19.—Elevation adjustments for wind during and period prior to probable maximum precipitation for high-dew point case

Elevation		Wind (% 1,000-mb wind)
Ft.	m	
1,000	305	107
1,500	457	118
2,000	610	141
3,000	914	195
4,000	1,220	215
5,000	1,524	225
6,000	1,829	235
7,000	2,134	245

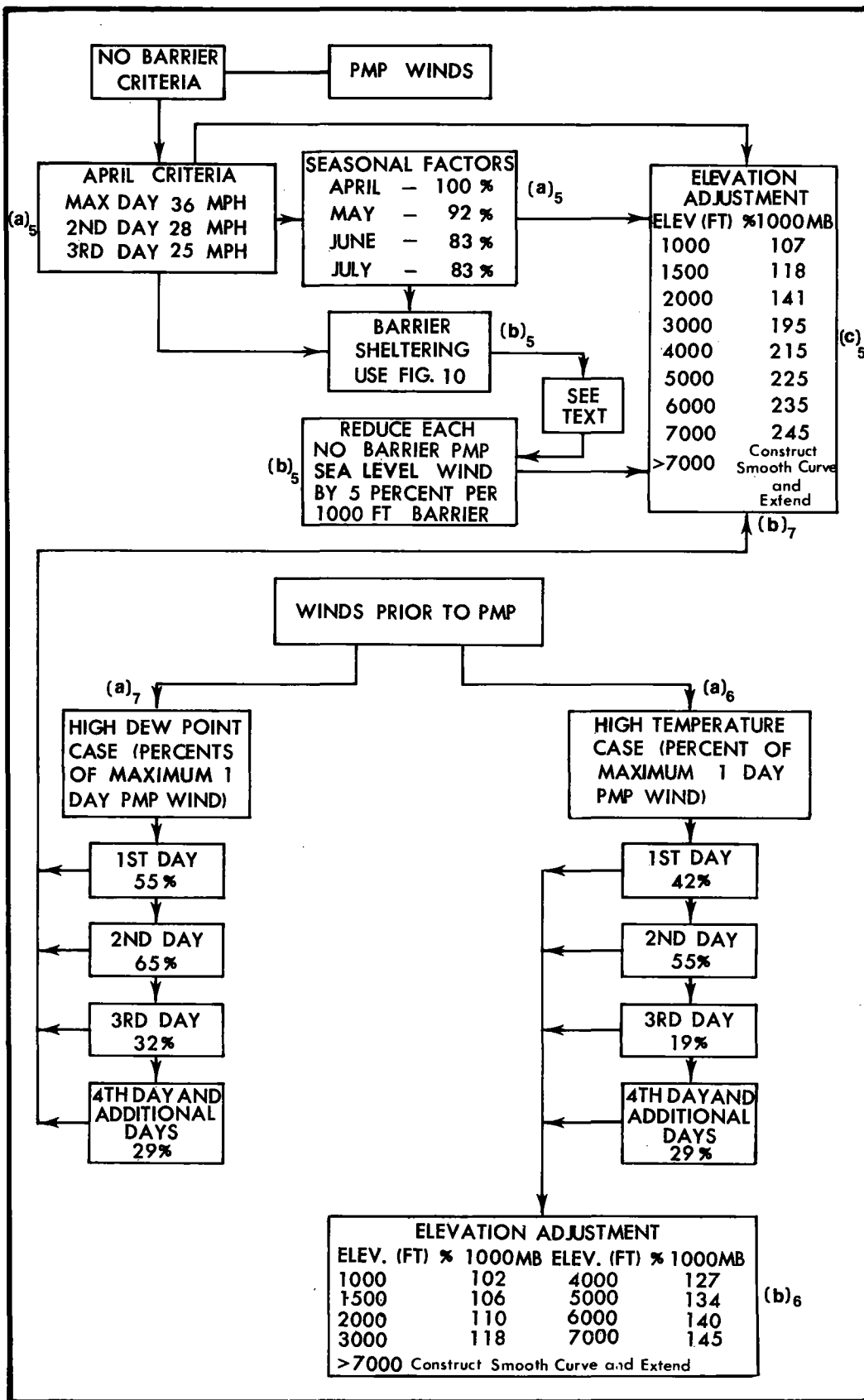

Figure 36.—Schematic for snowmelt wind criteria.

Some of the support for the elevation variation of wind primarily stems from generalizations employed in the Bradley Creek estimate (U.S. Weather Bureau 1961) which was based partly upon more extensive work done in generalized estimates along the west coast of the United States (U.S. Weather Bureau 1961, 1966b). High-dew-point situations in southeast Alaska support a large increase in wind with height above the lowest layers.

Because of the nature of the terrain in southeast Alaska, together with a pronounced overall stabilizing effect of the cold waters on the low-level winds, we concluded that the most pronounced increases in winds should take place somewhat above the surface layers. This is unlike the variations for both the coast range and the Sierras of California where sharp increases of wind with elevations in the low levels are more realistic. (This is due to extensive mountain chains providing a greater disturbance and mixing of air).

4.4.2 Winds Prior to Probable Maximum Precipitation

Sequences of winds were generalized for periods prior to the 3-day PMP for both high-dew-point and high-temperature situations. The main differences between high-temperature and high-dew-point cases are for the first 3 days prior to the first day of the PMP. For durations beyond this number of days (that is, 3 days of PMP and 3 prior days) differences between these two situations must diminish or, if very long sequences are required, probably reverse, since maximum sustained (or average) winds for long durations such as a month exert some definite limitations on the sequences of duration that are of many days' duration.

4.4.2.1 Winds Prior to Probable Maximum Precipitation - High-Dew-Point Case.

For wind criteria prior to PMP in the high-dew-point case, winds as percentages of maximum 1-day PMP wind are 55, 65, and 32 percent, respectively for 1, 2, and 3 days prior to the first day of the 3-day PMP. For the fourth day prior and for additional days prior to 4 days, 29 percent is to be used. These wind criteria are shown schematically on figure 36. These adopted percentages, combined with the wind for the 3 days of PMP, would give a 6-day average surface wind of about 26 mph (11.6 m/s). As a basis for judging the reasonableness of this 6-day average, the highest Juneau wind for 5 consecutive days was 18.5 mph (8.3 m/s) on May 4-8, 1958. Annette's highest 5-day wind was 21.4 mph (9.6 m/s).

Our 6 days of wind criteria with the suggested 29 percent (for the high-dew-point case for additional days prior to the 3-day PMP (fig. 36) would result in a month of maximum wind (not reduced for over-snow occurrences) of about 17 mph (7.6 m/s). This is approximately twice the mean April wind for Juneau. For Juneau the highest observed average monthly wind for May was equal to 1.4 times the mean, or 11.2 mph (5.0 m/s) in May 1955. Other data support the idea that a monthly average wind of about one and one-half times the mean is a rather extreme wind for such a duration. This, then, offers constraints on winds of duration shorter than a month but longer than a few days. Thus, for the windier high-dew-point case, it appears our wind criteria are amply severe for durations beyond that of the 3-day PMP.

The adopted wind criteria, based much on prior Alaskan work (e.g., U.S. Weather Bureau, 1966a) gives a wind ratio between monthly and 5-day values of 0.61. This ratio is the same as one derived from Juneau's maximum winds, a 11.2 mph (5.0 m/s) wind for the month and a 18.4 mph (8.2 m/s) wind for 5 days.

The elevation variation of wind in the high-dew-point prior-to-PMP case is the same as that for the 3-day PMP winds (table 19).

4.4.2.2 Winds Prior to Probable Maximum Precipitation - High-Temperature Case.

For wind criteria prior to PMP for the high-temperature case, the adopted winds as percentages of the maximum 1-day PMP wind are 42, 55, and 19 percent, respectively for 1, 2, and 3 days prior to the first day of the 3-day period. These criteria are less than those adopted for the high dew point prior to the PMP case. For the fourth day prior to the PMP and for additional earlier days, 29 percent is to be used. These wind criteria are also shown schematically on figure 36.

4.4.2.3 Elevation Variation of Winds in High-Temperature Case. The variation of wind with height for the high-temperature case is shown in table 20. This table was developed from the prior studies for specific Alaskan basins.

Table 20.—Elevation adjustments for wind for high-temperature case prior to probable maximum precipitation

Elevation		Wind
ft.	(m)	(% of 1,000-mb wind)
1,000	305	102
1,500	457	106
2,000	610	110
3,000	914	118
4,000	1220	127
5,000	1524	134
6,000	1829	140
7,000	2134	145
>7,000	construct smooth curve and extend.	

4.5 Support for Adopted Wind and Temperature Criteria

In a recent climatic atlas for Alaska (Brower et al. 1977), a comparison of a considerable amount of summarized data supports the similarity of climate between the south coast and southeast Alaska. Also, supported in this Atlas are the various combinations of data used in the generalized snowmelt portion of this report. One important example of the latter is the dual combination of light winds with the high-temperature prior-to-PMP melt sequence and the stronger winds with the lower-temperature (but higher dew-point) sequence. These dual melt criteria and the similarity of these criteria for the south coast and southeast Alaska are both supported by the climatic data. Figure 37, taken from Brower's work, shows for May as an example, the similarity for areas C, D, and E (South Coast) with F (southeast Alaska). The stronger winds are associated with the "moderate" (neither high nor low extremes) marine climate temperatures. High temperatures can be seen to be associated with light winds from the same figure. This is consistent with the synoptic conclusions on high insolation melt situations common to the south coast and southeast Alaska, as well as the interior.

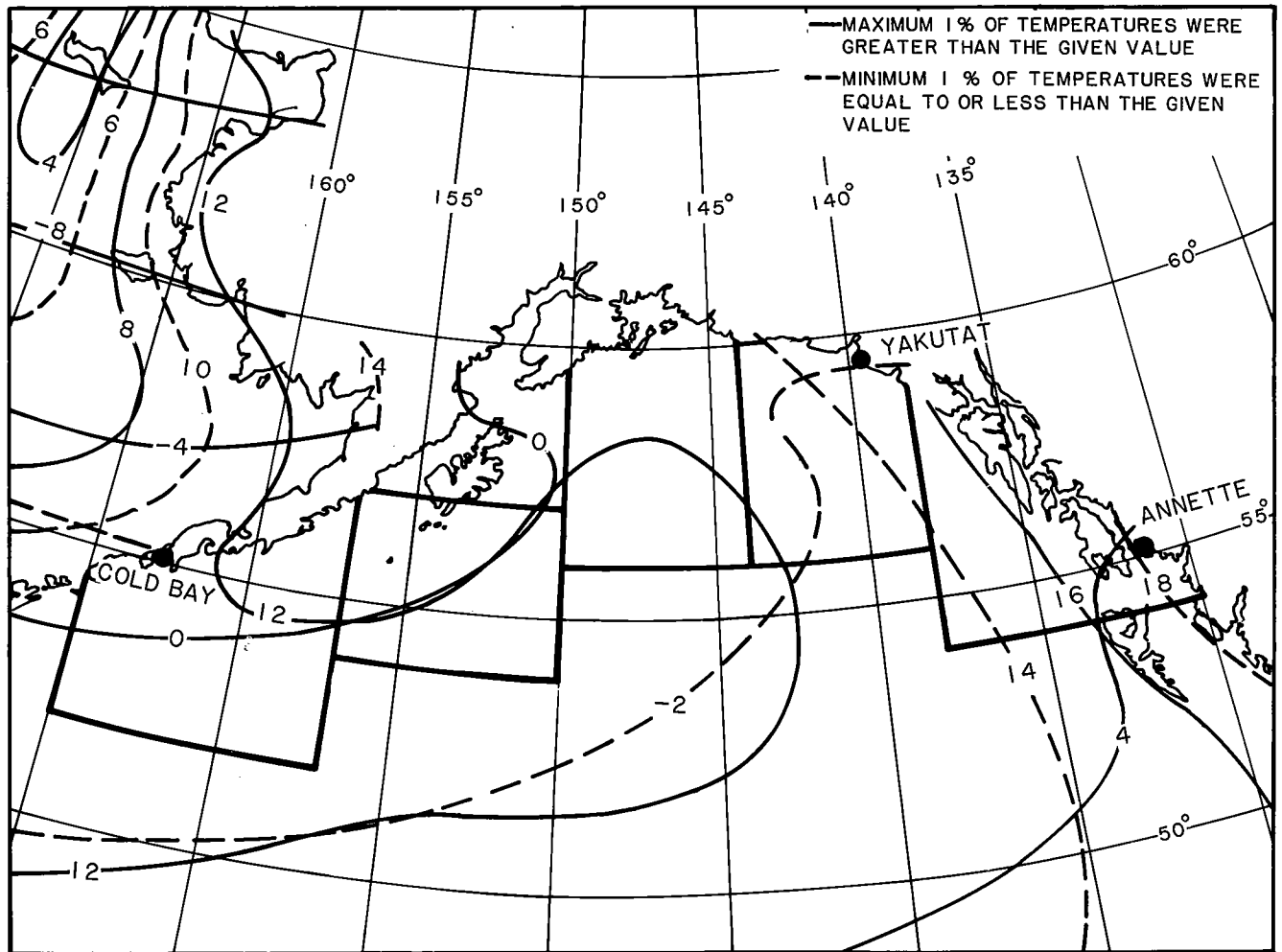

Marine Area C

TEMP (°C)	WIND SPEED (KTS)				
	0-3	4-10	11-21	22-33	≥ 34
16.17	0	+	+	0	0
14.15	1	1	+	0	0
12.13	1	2	1	0	0
10.11	3	4	2	+	0
8.9	4	10	5	1	+
6.7	5	11	13	3	+
4.5	2	8	9	3	1
2.3	2	2	3	2	1
0.1	+	+	+	+	+
-2.-1	+	0	+	+	+
-4.-3	0	0	0	0	+

1171

Marine Area D

TEMP (°C)	WIND SPEED (KTS)				
	0-3	4-10	11-21	22-33	≥ 34
16.17	+	+	+	0	0
14.15	+	+	+	0	0
12.13	1	1	+	+	0
10.11	2	4	2	+	0
8.9	3	8	7	1	+
6.7	5	14	16	4	1
4.5	1	8	10	4	1
2.3	+	2	2	1	1
0.1	0	+	+	+	+
-2.-1	0	+	0	0	+
-4.-3	0	0	0	0	0

1943

Marine Area E

TEMP (°C)	WIND SPEED (KTS)				
	0-3	4-10	11-21	22-33	≥ 34
16.17	+	+	+	0	0
14.15	+	1	+	0	0
12.13	+	2	1	0	0
10.11	2	4	3	+	0
8.9	4	10	10	2	+
6.7	3	15	15	5	1
4.5	1	6	7	2	1
2.3	+	2	2	+	+
0.1	0	0	+	+	+
-2.-1	0	+	0	0	0
-4.-3	0	0	0	0	0

1110

Marine Area F

TEMP (°C)	WIND SPEED (KTS)				
	0-3	4-10	11-21	22-33	≥ 34
20.21	0	+	0	0	0
18.19	+	+	+	0	0
16.17	+	1	1	0	0
14.15	+	2	+	0	0
12.13	1	5	2	+	0
10.11	3	11	5	1	+
8.9	4	15	12	3	1
6.7	2	9	11	4	+
4.5	1	2	2	+	+
2.3	+	+	+	+	0
0.1	0	0	0	0	0

1454

5 Air temperature extremes (°C)

May

Figure 37.—Relation of wind to temperature for differing marine areas (from Brower et al. 1977).

4.6 Stepwise Procedure for Snowmelt Criteria (Other Than Snowpack)

We shall now briefly give the steps for obtaining snowmelt by the application of criteria that are shown schematically in figures 33 (temperature), 35 (dew point), and 36 (wind). The steps in sections 4.6.1 through 4.6.7 are identified on the appropriate figures with subscripts relating to the lettered step and numbered section, e.g., (b)₁ indicates step b. in section 4.6.1.

4.6.1 Steps for Obtaining Temperatures Prior to Probable Maximum Precipitation.

The schematic of figure 33 shows an outline of this sequence of steps.

- a. Read sufficient midmonth values of mean monthly 1000-mb temperatures (fig. 31) at the center of the basin to construct a smooth temperature-time relation for interpolation of first day prior to the 3-day PMP event.
- b. Apply the departures for high-temperature case shown (b)₁ in figure 33 to the value from step (a)₁. If any temperature higher than 62°F (16.7°C) results, use 62°F (16.7°C) for such cases.
- c. Apply the departures for high-dew-point case shown (c)₁ in figure 33 to the value from step (a)₁.
- d. Obtain elevation-adjusted values by subtracting 4°F/1,000 ft (2.2°C/305 m) for the high-temperature case (d)₁ (temp) and 3°F/1,000 ft (1.7°C/305 m) for the high-dew-point case (d)₁ (d.p.), respectively, to the low-level values obtained in steps (b)₁ and (c)₁.

4.6.2 Steps for Obtaining Dew Points Prior to Probable Maximum Precipitation

The schematic of figure 35 shows an outline of the sequence of these steps.

- a. For the high-temperature case, apply the adjustment shown (a)₂ under high-temperature case (fig. 35) to the values obtained in steps (b)₁, or (d)₁ (temp.). Application to step (d)₁ (temp.) values allows for the -4°/1,000 ft (-2.2°C/305 m) elevation adjustment, and an additional adjustment for elevation should not be applied.
- b. For the high-dew-point case, apply adjustments shown (b)₂ in figure 35 for the high-dew-point case to the values obtained in steps (c)₁, or (d)₁ (d.p.). For example, for the fourth day prior to the first day of the 3-day PMP event in the high-dew-point case, the dew point is 6°F (3.3°C) less than the temperature for the fourth day prior to first day of the 3-day PMP event. Again, as in step (a)₂ of this section, the use of step (d) (d.p.) values allow for the appropriate elevation variations, which in the high-

dew-point case is $-3^{\circ}\text{F}/1,000\text{ ft.}$ ($-1.7^{\circ}/305\text{ m}$), and an additional adjustment should not be applied.

4.6.3 Steps for Daily Dew Points and Daily Temperatures During Probable Maximum Precipitation

Since temperatures during the 3-day PMP event are the same as the dew points, the sequence of 24-hr dew points are determined (fig. 35). The half-day temperature and dew-point problem is covered under section 4.6.4.

- a. To get daily dewpoints (and, also temperatures) during the 3-day PMP event, midmonth daily maximum dew points are read from the center of the basin in appropriate maps in figure 34.
- b. From midmonth maximum values from step (a)₃, plot and obtain from a smooth curve connecting the values the appropriate maximum 1-day dew point (and also therefore temperature) for maximum day of the 3-day PMP event.
- c. For second highest day of the 3-day PMP event, subtract 2°F (1.1°C) from value in step (b)₃.
- d. For the third highest day of the 3-day PMP event, subtract 4°F (2.2°C) from value in step (b)₃.
- e. For elevation variation, apply $-3^{\circ}\text{F}/1,000\text{ ft}$ ($-1.7^{\circ}\text{C}/305\text{ m}$) to the values in steps (b)₃, (c)₃, and (d)₃.

4.6.4 Steps for Obtaining Half-Day Dew-Point and Temperature Values.

The schematic illustrating the steps for obtaining half-day dew-point values is the lower half of figure 33 while that for half-day temperature values is shown on the lower part of figure 35.

For basins not located at sea level, required elevation adjustments should be completed prior to proceeding to the steps for obtaining half-day values.

- a. For half-day dew-point and temperature values during the 3-day PMP event, apply $\pm 2^{\circ}\text{F}$ ($\pm 1.1^{\circ}\text{C}$), (a)₄, to the values obtained in steps (b)₃ through (d)₃ or (e)₃ as appropriate (fig. 35).
- b. For prior to the 3-day PMP event half-day dew-point criteria for the high-temperature case, apply $\pm 3^{\circ}\text{F}$ ($\pm 1.7^{\circ}\text{C}$), (b)₄, to the appropriate values from step (a)₂.
- c. For prior to the 3-day PMP event half-day dew-point criteria for the high-dew-point case, apply $\pm 2^{\circ}\text{F}$ ($\pm 1.1^{\circ}\text{C}$), (c)₄, to the appropriate values obtained in step (b)₂.

- d. For half-day temperatures prior to the 3-day PMP event, for the high-temperature case, apply $\pm 9^{\circ}\text{F}$ ($\pm 5.0^{\circ}\text{C}$), $(d)_4$, to the values obtained in steps $(b)_1$ or $(d)_1$ (temp.), as appropriate.
- e. For half-day temperatures prior to the 3-day PMP event for the high-dew-point case, apply $\pm 6^{\circ}\text{F}$ ($\pm 3.3^{\circ}\text{C}$), $(e)_4$, to the values obtained in steps $(c)_1$ or $(d)_1$ (d.p.), as appropriate.

4.6.5 Steps for Obtaining Winds During Probable Maximum Precipitation

Figure 36 is the schematic showing wind criteria.

- a. The 3 days of April sea-level wind of 36, 28, and 25 mph (16.1, 12.5, and 11.2 m/s) are multiplied by appropriate percent (mid-April = 100 %) to obtain the 3 days of wind for the chosen date of PMP placement (fig. 36). The percents shown in figure 36 are midmonth values, and values for intermediate dates should be interpolated as necessary.
- b. To determine the barrier influencing a basin, lines are drawn from the center of the basin toward 256° , 229° , 202° , 175° , and 148° . The maximum barrier from figure 5 along each of these lines that reaches a moisture source is tabulated and the average of these determined. The barrier reduction to winds is then determined as the product of the average of the elevations in thousands of feet times 5 percent. The surface winds from step $(a)_5$ are reduced by this percentage.
- c. To adjust the barrier adjusted sea-level winds for elevation to provide a wind profile, the elevation adjustment is applied to the winds of step $(b)_5$. The percentage adjustments are determined from the elevation adjustment box, $(c)_5$, in figure 36. For example, for 2,000 ft (610 m) the values from step $(b)_5$ are multiplied by 1.41.

4.6.6 Steps for Obtaining Winds Prior to the 3-Day Probable Maximum Precipitation - High-Temperature Case

The lower right-hand side of figure 36 shows a schematic of the steps required to develop winds prior to the PMP storm for the high-temperature case. These steps are:

- a. For the high-temperature wind sequence, the maximum barrier-adjusted 1-day sea-level wind from step $(b)_5$ is multiplied by the percents shown in the boxes on the lower right side of figure 36. Thus, for a wind sequence leading up to the PMP these percentages are: 29, 29, 29, 19, 55, and 42.

- b. The elevation variation for the high-temperature case winds from step (a)₆ comes from application of the percentages in the elevation adjustment box near the bottom of figure 36. For example, for 2,000 ft (610 m), the winds from step (a)₆ are multiplied by 1.10, or for 6,000 ft (1,829 m) by 1.40.

4.6.7 Steps for Obtaining Winds Prior to the 3-Day Probable Maximum Precipitation — High-Dew-Point Case

The lower left-hand side of figure 36 shows the schematic of the steps required to develop winds prior to the PMP storm for the high-dew-point case. These steps are:

- a. For the high dew-point wind sequence, the maximum barrier adjusted 1-day wind from step (b)₅ is multiplied by the percents shown in the boxes at the lower left side of figure 36. Thus, for a wind sequence leading up to the 3-day PMP event, these percentages are 29, 29, 29, 32, 65, and 55.
- b. The elevation variation for the high-dew-point case winds from step (a)₇ comes from application of the percentages in the elevation adjustment box in the upper right corner of figure 36. (This is the same elevation used for winds during the 3-day PMP storm, step (c)₅.) For example, for 2,000 ft (610 m) the winds from step (a)₇ are multiplied by 1.41, or for 6,000 ft (1,829 m) by 2.35.

4.7 Snowpack Criteria

4.7.1 Introduction

The development of generalized snowpack criteria involved (a), the integration of a variety of data including snow-related data that went into the development of the MAP chart (chapter 2), (b) the use of certain guiding principles related to geographical and weather-related controls of snow accumulation and retention, and (c), preliminary computations at a variety of locations and subsequent development of appropriate charts to synthesize overall consistency. The resulting procedure allows for regional, elevation, and seasonal variations. The charts and stepwise procedure thus allows the user to obtain, for a particular basin, snowpack and subsequent critical melt for a variety of placement dates of PMP.

4.7.1.1 Working Hypotheses. Other things being equal, snowpack must increase inland (for given elevations of comparable exposure, etc.) due to a temperature-dependent factor. Over our study area, temperatures decrease inland, generally from southwest-to-northeast, resulting in increased snowpack (for the same MAP, for example) since more of the precipitation within storms falls in the form of snow, and the season for snow begins sooner and ends later as one moves away from the coast. We need to keep in mind, that here we are referring to a temperature factor (or gradient) related to distance away from the warmer coastal areas.

Temperature reduction, as related to elevation, is a separate matter. The elevation-dependent temperature factor is dealt with later by a tie-in of snowpack with regional variations of MAP.

Since our snowpack procedure relates strongly to MAP, we need to clarify certain principles related to our use of the MAP for the study area to estimate snowpack. The underlying principles of interpretation and use are:

- a. A large quantity of data, including snow-related data, went into the MAP chart.
- b. For snowpack purposes, one possibility considered was the use of a MAP index which would maximize snowpack (implicitly at all elevations) by using a certain ratio (e.g., 125 percent) of MAP to represent an unusual year.
- c. Since overly excessive snowpacks (i.e., more than could melt in a season) result at the higher elevations from application of b., we chose to use the unadjusted MAP chart in a manner which accomplishes the desired aim of maximizing snowpack (compared to normal) at the lower elevations, especially where smaller snowpacks typically exist that can be melted in a hydrologically critical period.

4.7.2 Background Data

A variety of information is available which provides perspective on the magnitude of snowpack that could be present prior to the PMP. Some of these data can only be used indirectly.

4.7.2.1 Snow-Course Data. Some snow-course data were available within the study region. These data were limited in length of record and did not sample the entire range of elevations and exposures in southeast Alaska. The maximum observed values (table 21) at these locations do, however, provide a lower limit to an extreme snowpack compatible with the PMP.

Table 21.—Maximum observed and mean snowpack water-equivalent values for selected snowcourses in southeast Alaska

Name	Elevation		Maximum observed		Mean	
	ft	m	in.	mm	in.	mm
Crater Lake	1,750	533	87.5	2,222	70	1,778
Speel River	280	85	52.0	1,320	35	889
Long Lake	1,080	329	59.0	1,499	46	1,168
Douglas Ski Bowl	1,640	500	42.0	1,067	38	965
Range in mean snowpack values for snow courses near Ketchikan for two elevations	660	201	-	-	27-34	686-864
	2,000	607	-	-	66-71	1676-1803

4.7.2.2 Station Data. One approach for determining maximum snowpack is the use of a "synthetic season." This approach played an important role in Yukon estimates (U.S. Weather Bureau, 1966a). In this method, the maximum observed snowpack value for each month for a station is combined without regard to the year of occurrence. This synthetic season approach was also used in this study for southeast Alaska as an aid in defining snowpack. For example, the synthetic season snowpack water equivalents for two widely separated stations, Juneau and Tree Point Light Station, were 17 in. (432 mm) and 65 in. (1651 mm), respectively. Each station had a MAP of approximately 100 in. (2540 mm). The synthetic season approach was used for all useful data in southeast Alaska with initial values "normalized" to remove orographic effects with initial "shaping" determined by two reasonable hypotheses (sec. 4.7.1).

Statistical estimates of water equivalent amounts provide another approach useful where reasonable lengths of record are available. Such estimates of snowpack water equivalents were made from seasonal maximum data at Juneau and Annette using the Fisher-Tippett type I distribution. These gave estimated 1 percent frequency values of about 11.5 in. (292 mm) for Juneau and about 6 in. (152 mm) for Annette.

4.7.2.3 Snowmelt Computations. A method was developed, chapter 2, for estimating snowmelt from monthly and seasonal streamflow data with adjustments for concurrent precipitation. The 1963-64 season was quite unusual for snow cover and the subsequent snowmelt. The estimated snowmelt (taking note that the contributing portion of the basin differs as melt progresses) for five basins (fig. 5 for locations) in 1964 were:

1. Perserverance Creek, 28 in. (711 mm).
2. Fish Creek near Ketchikan, 34 in. (864 mm).
3. Manzanita Creek, 42 in. (1067 mm).
4. Winstanley Creek, 34 in. (864 mm).
5. Baranof River, 71 in. (1803 mm).

4.7.2.4 Previous Snowpack Estimates. A prior detailed estimate for Long Lake Drainage resulted in estimated values of snowpack (water equivalent) from 50 in. (1270 mm) at 814 ft (248 m) to 90 in. (2286 mm) at 3,500 ft (1,067 m) for April 15. This study also provided important input to the present study.

4.7.3 Procedure for Snowpack Determination

The total snowpack for this region was determined through a series of steps. These steps then form the basis for the stepwise procedure the user follows to determine maximum snowpack for individual basins. The first approximation is based on the MAP. This is adjusted for the percent of MAP that occurs as rain (i.e., length of accumulation season) and the amount of snow that melts between the end of the snow accumulation season and the beginning of snowmelt computations for the PMP. In addition, the first approximation snowpack is also adjusted geographically for factors not handled in determining the first approximation snowpack.

4.7.3.1 First Approximation to Snowpack. The generalized MAP of figure 4 provides the basis for determining a first approximation to the accumulated snowpack for individual basins. Where the MAP is less than 150 in. (3810 mm), an average value for the basin can be used as the first approximation. For basins where the average MAP is 150 in. (3810 mm) or greater, an average value should not be used as our first approximation. For these basins, it is desirable to indicate the distribution of MAP through the elevations range of the basin rather than use a single average value throughout the basin. Allowing a uniform distribution of MAP for these basins with MAP larger than 150 in. (3810 mm) would be equivalent to stretching the distribution of MAP to unrealistic proportions. The procedure, therefore, must not permit unrealistically large snowpack accumulations. We have adopted the scheme of using two-thirds of the basin average MAP at the lowest elevation and four-thirds of the basin average MAP at the highest elevation of the basin. The variation between these two extremes is linear. This is shown schematically in figure 38 for an average basin MAP of 150 in. (3810 mm) for three basins. In each case the lowest elevation is sea-level with the highest elevation varying by 1,000-ft increments.

4.7.3.2 Adjustment for Length of Snow Accumulation Season. Only a portion of the MAP in southeast Alaska occurs as snow. The first adjustment to the estimated snowpack water equivalent is to make allowances for the longer snow accumulation season at higher elevations compared to the lower elevations where mean temperatures are higher. In addition, we need to allow for melt, if any, between the end of the snow accumulation season and the date selected for the PMP event.

Figure 39 was developed from accumulation and melt season variations with elevation used as input to the MAP chart. For maximizing of snowmelt, some additional conservativeness was built into the curve labeled "curve for beginning melt" (fig. 39) by use of a delay of 15 days from the mean melt date for each elevation. This increases the snow accumulation season, the sloping elevation lines on figure 39. Thus, the percents of MAP in this chart (ordinate) reflect this 15-day extension. Additionally, figure 39 provides the user with the number of days of melt for each elevation that he must allow for based upon the date selected for the PMP event. For example, if the PMP event were to begin May 15, then figure 39 (proceed vertically from the May 15 mark to say the 1,000-ft (305-m) elevation) shows that prior snowmelt would have to begin more than a month prior to May 15. In actual computations, the required melt for reducing snowpack water equivalent (in inches) is given directly in figure 40 for any desired beginning date for the placement of the 3-day PMP event (hereafter referred to as the placement date).

4.7.3.3 Melt Between End of Snow Accumulation Season and Probable Maximum Precipitation. For some basins, the range of elevations is large. For these basins figure 40 is needed to determine the amount of melt that must be assumed for reducing the snowpack water equivalent. This figure was derived from mean melt data used in chapter 2 as an aid in determining MAP from snow course date, etc. Figure 40 provides (for a given elevation) the estimated amount of melt for the period covered by a horizontal elevation line from the "melt begin" dashed curve of figure 39 to its intersection with a vertical line for the placement date (i.e., abscissa of figure 39). Discussion of these increasing

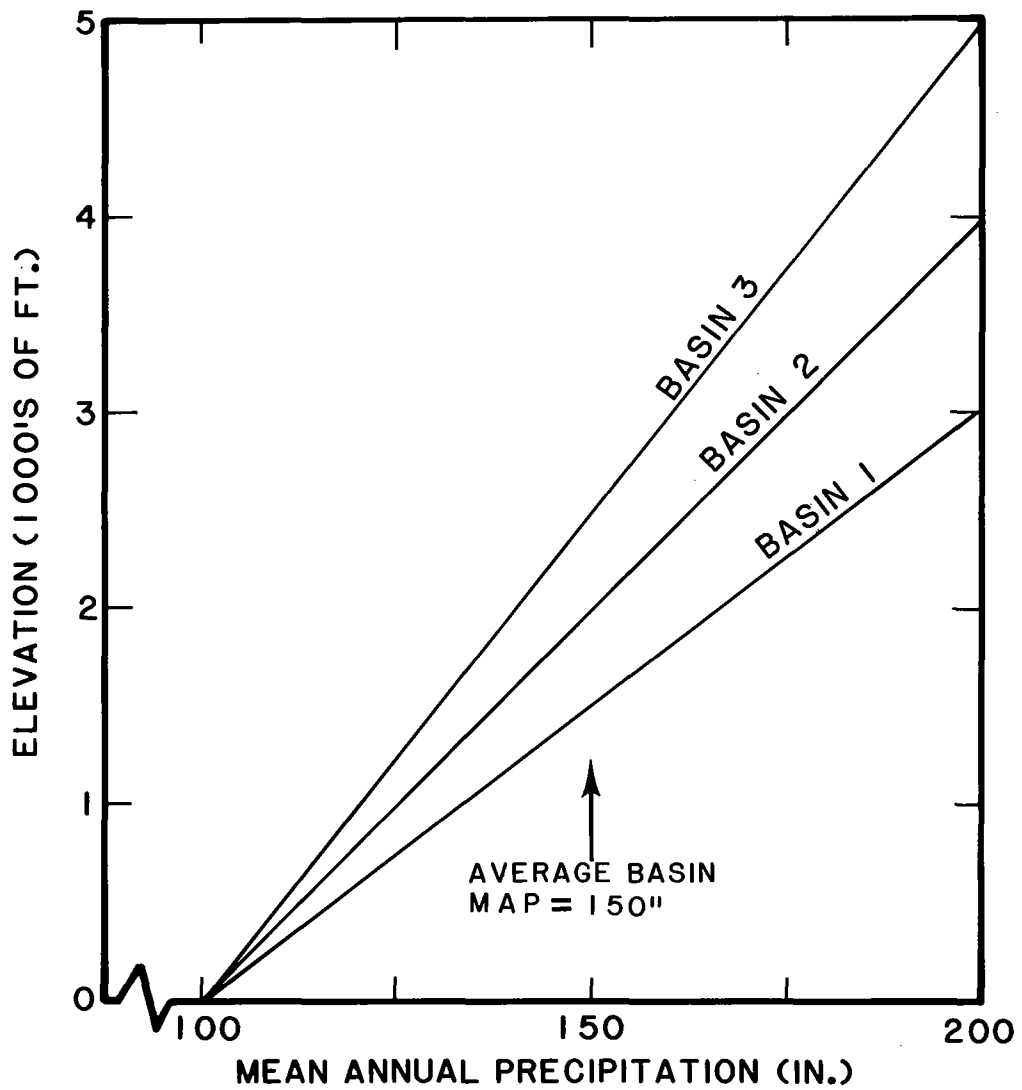

Figure 38.--Schematic for illustrating how mean annual precipitation variation can be determined for use in snowpack accumulations when mean annual precipitation \geq 150 in. (3810 mm).

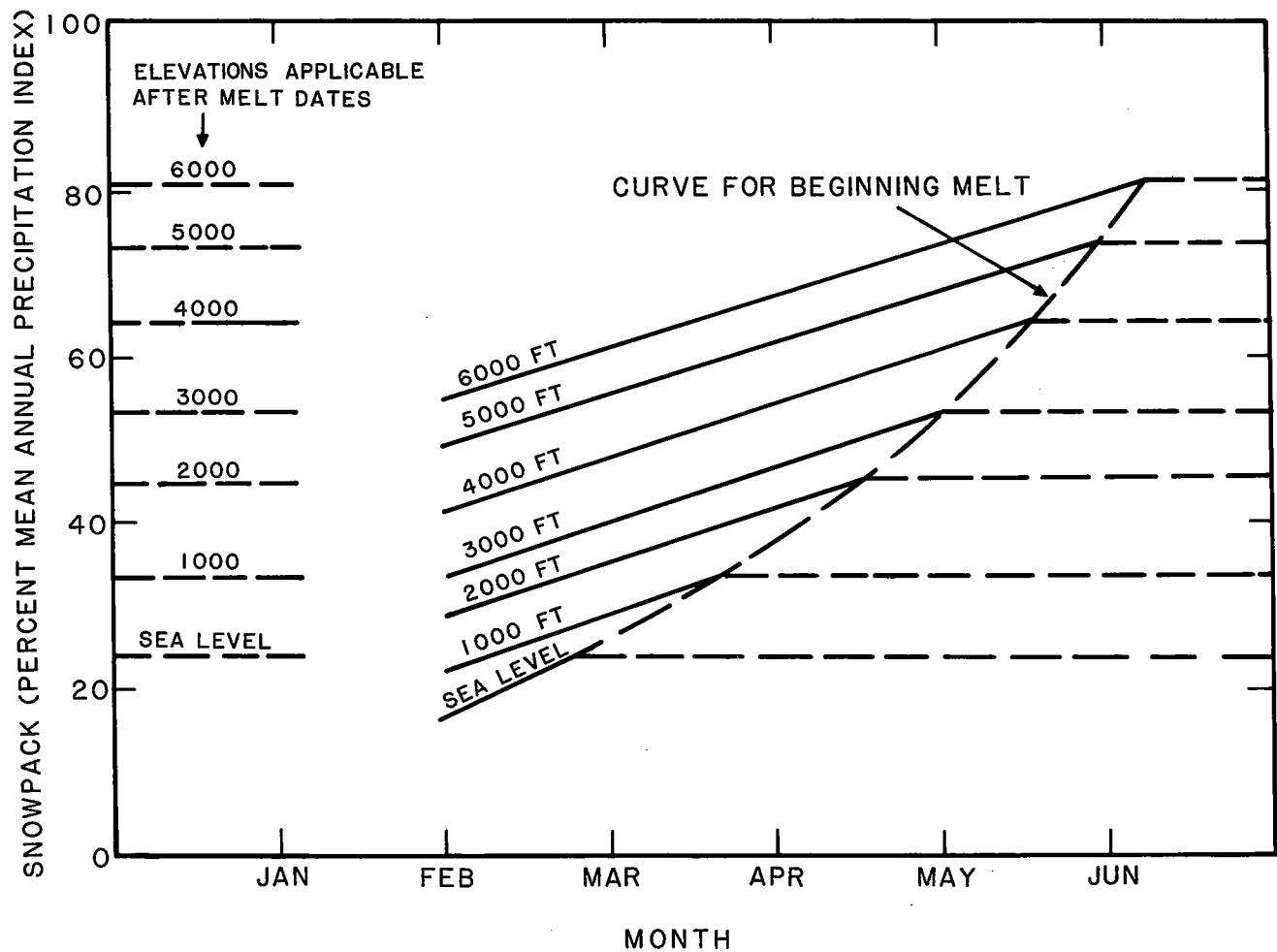

Figure 39.—Snowpack related to month and elevation as percent of mean annual precipitation.

melt rates with season was covered in chapter 2. The water equivalent melt (abscissa of fig. 40) results from multiplying days during the melt period from figure 39 by the adopted mean melt rates of chapter 2.

4.7.3.4 Geographic Variation. The snow accumulation season varies across southeast Alaska as a function of distance from the relatively warmer waters of the Pacific. The 100-percent curve (fig. 41) represents basic values of snowpack from application of appropriate percents for basin elevations to MAP values from figure 6. The placement of the 100 percent curve on this figure is empirically determined as is the spacing for lower and higher percentages. The magnitude and shaping of the lines of figure 41 comes from a compositing of all pertinent clues from various types of data and studies discussed in section 4.7.2 and from basic principles discussed in section 4.7.1. For a given MAP and elevation, the net result is to allow for greater snow accumulation (snowpack) inland and away from the warmer maritime influences.

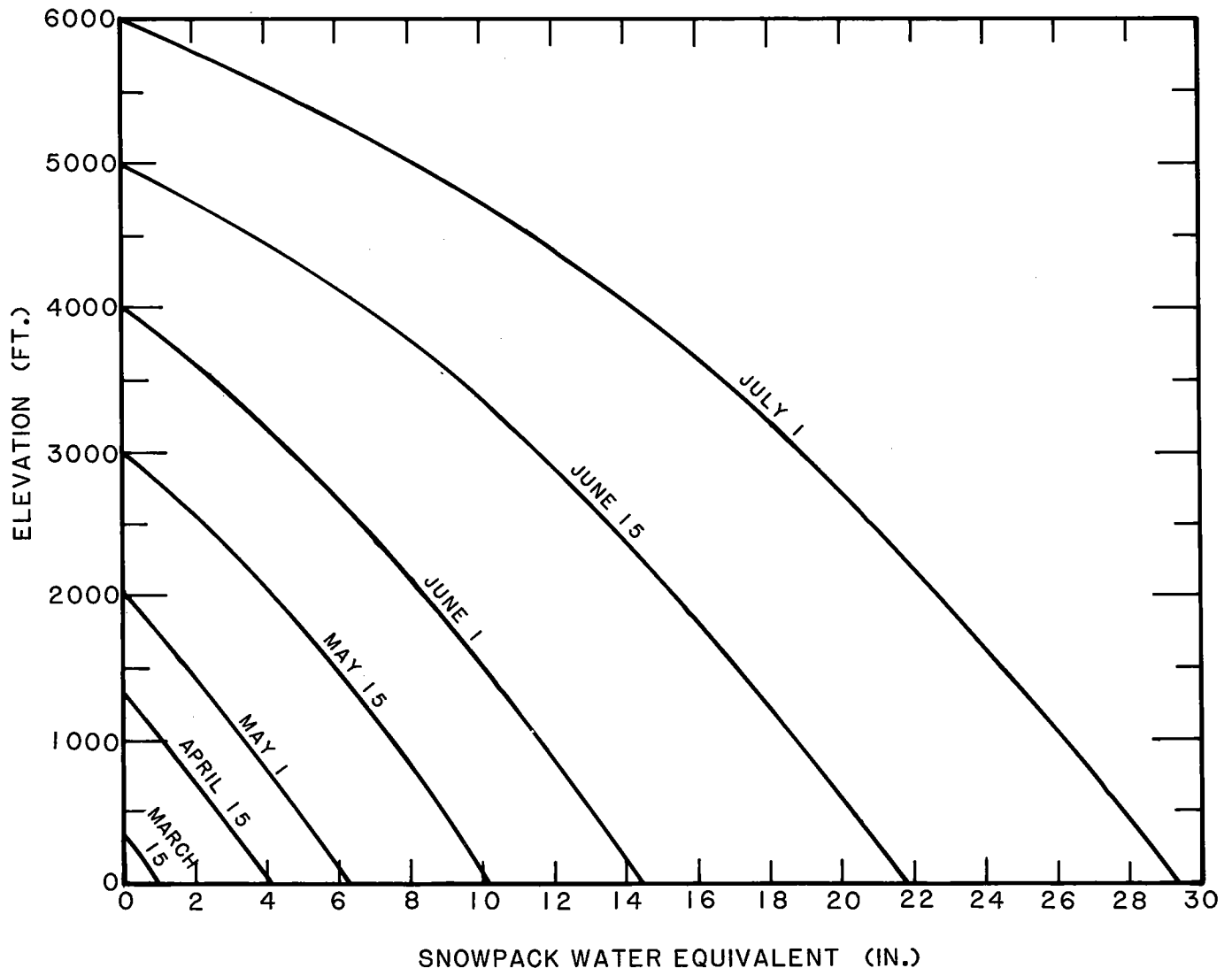

Figure 40.—Required melt for period of time up to probable maximum precipitation.

4.7.4 Stepwise Procedure for Snowpack (Water Equivalent) Determination

Figure 42 is a schematic that shows the steps to determine the appropriate snowpack water equivalent for use with PMP. These steps are:

- a. Outline basin on 1:1,000,000 or other suitable base map.
- b. Determine from an appropriate topographic chart the mean elevation for the basin, if not already available.
- c. Superimpose basin on figure 6 (MAP) and determine MAP for the basin. If the basin MAP is less than 150 in. (3810 mm), use MAP value uniformly throughout the

basin. If the basin MAP is \geq 150 in. (3810 mm), use two-thirds MAP at lowest elevation and four-thirds MAP at highest elevation assuming a linear variation between the values at the lowest and highest elevation.

- d. Select a placement date for the 3-day PMP event.
- e. Using date selected in d., locate this melt date on figure 39 and move vertically to appropriate horizontally extended elevation line(s) and read from vertical scale (coordinate in percent) the appropriate percent(s) of MAP.
- f. Multiply the MAP value(s) from step c. by the appropriate "same elevation" percent(s) from step e. to obtain first approximation snowpack value(s) for the basin.
- g. The first-approximation snowpack value(s) from step f. may need to be adjusted depending upon the basin location in relation to the ratio curves of figure 41. If the basin is on the curve labelled 1.0, no regional adjustment is required. Otherwise, the appropriate ratio from figure 41 is applied to the first-approximation value of step f.
- h. The adjusted snowpack value(s) from step f. or g. may need to be modified further for snowpack melt prior to snowmelt computation date (sec. 4.7.3.3). The value to be subtracted from a given snowpack value from step f. or g. is determined by the use of figure 40. The elevation and melt date (curved lines of fig. 40) are used to obtain the melt, if any, to be subtracted. This gives the melt-adjusted snowpack for a particular elevation.

If the basin of concern involves a wide elevation range with accompanying large variation in adjusted snowpack values, the user should construct an elevation-adjusted snowpack curve to check consistency and make smoothing adjustments or interpolations, as necessary.

- i. Apply snowmelt criteria (sec. 4.6) to snowpack from steps f., or g., if required, or h.
- j. Go back to step d. with new PMP placement date and repeat remainder of stepwise procedure until a critical placement date of the 3-day PMP event for maximizing combined PMP and snowmelt has been determined.

- k. (Optional) Use procedure outlined in steps a. through j. except instead of a mean elevation for the basin (step b.), use elevation increments or bands (i.e., making use of an area-elevation curve) if all snow at the lower elevations is apt to be melted in less time than the hydrologically critical time period.

4.7.5 Trial Computations and Comparisons.

The generalized stepwise procedure discussed in the previous section was used to compute snowpack for the following:

- a. At grid points.
- b. At grid points of high and low MAP.
- c. Along lines starting upwind of glaciers and extending into glacier areas.
- d. For numerous specific basins (using the mean elevation of the basin).
- e. For some basins from among those in d. using the elevation variations in the basin.
- f. For special locations where limited snow data and/or estimated snowmelt runoff were available.

These various computations were compared with previously summarized empirical data and results of studies (see section 4.7.2). Figure 43 shows a summation of computed snowpack values. These comparisons provide a means of evaluating the reasonableness of the procedure outlined for estimating snowpack. All computations of snowpack were made for May 15. One can see from figure 40 that for all cases with elevation of 3,000 feet (914 m) or above, the computed values did not need to be reduced for snowmelt. Below 3,000 ft (914 m) the user may use figure 40 to find how much melt (water equivalent) had to be subtracted from computed snowpack in individual cases.

From the many comparisons made, the following conclusions are noteworthy:

1. For Juneau, our procedure gives a snowpack water equivalent of near 30 in. (762 mm). This is based on

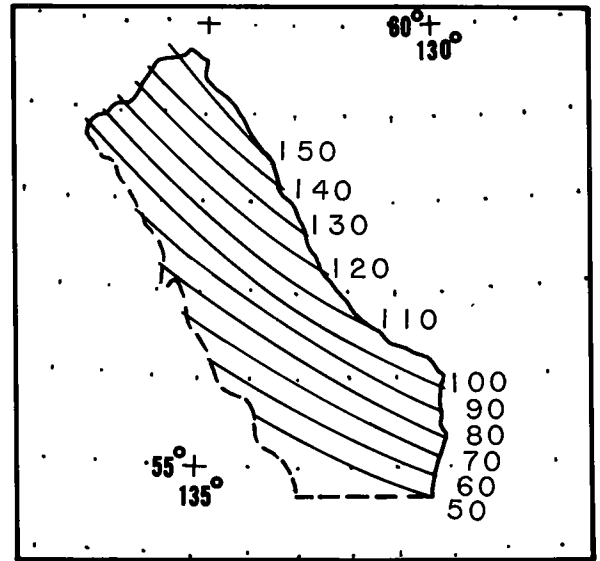

Figure 41.—Geographic variation of first approximation snowpack estimates (in percent).

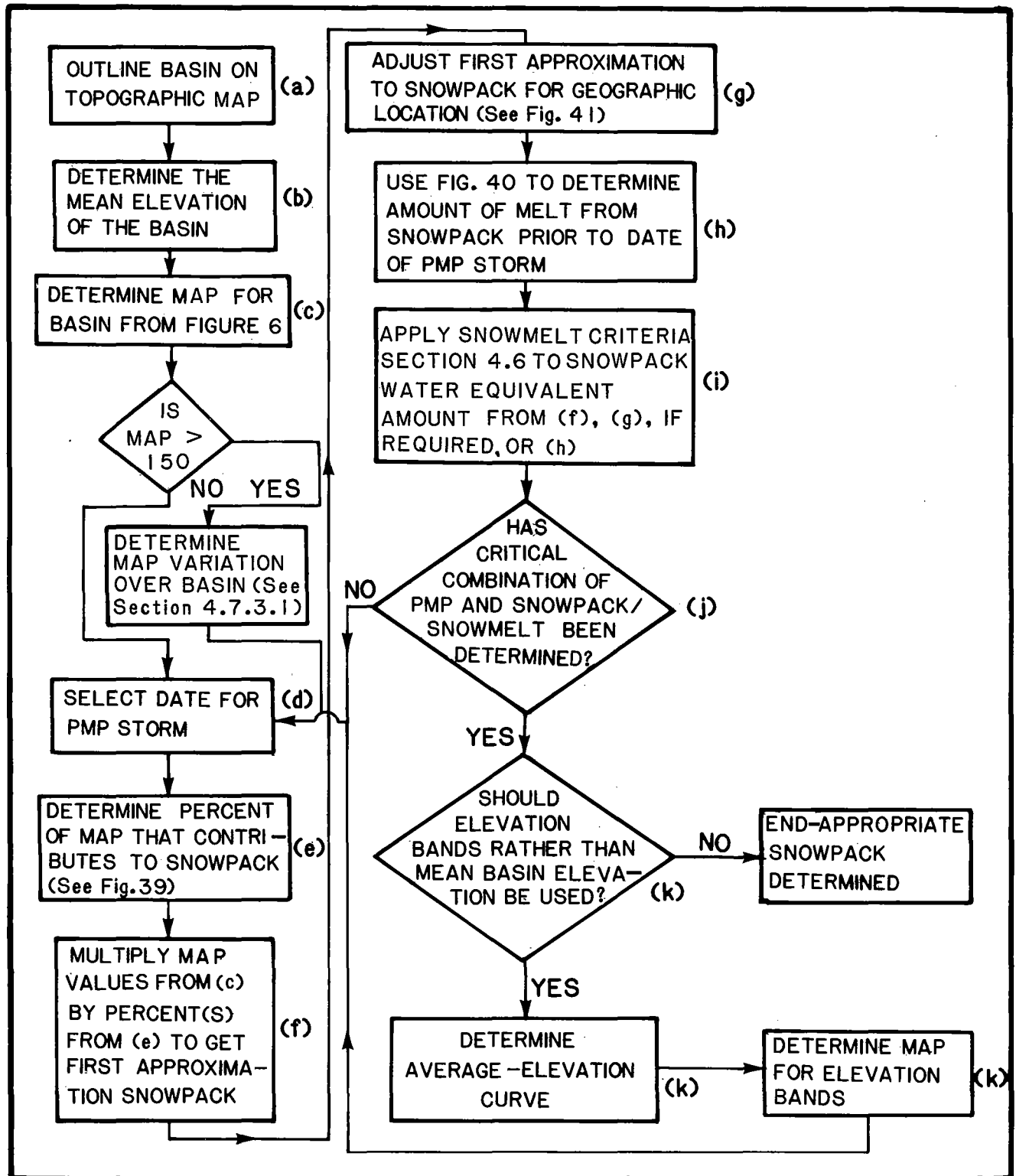

Figure 42.—Schematic of procedure to determine snowpack water equivalent for use with probable maximum precipitation.

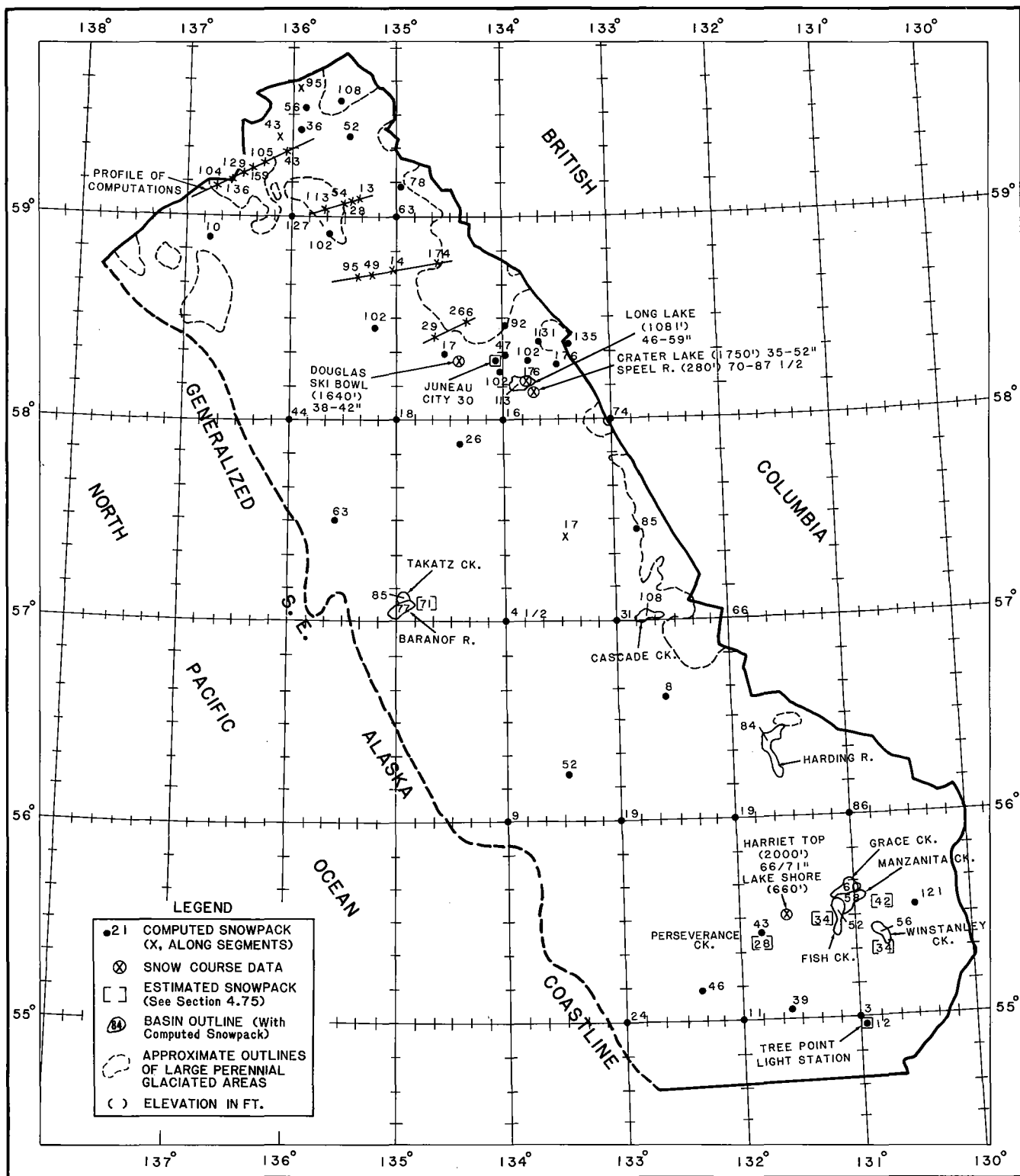

Figure 43.—Comparison of computed and observed snowpack values for various locations in southeast Alaska.

- a a MAP of 93 in. (2362 mm) (fig. 6), a location factor of 1.34 (fig. 41), and an elevation factor of 0.24 (fig. 39) ($93 \times 1.34 \times 0.24 = 29.9$). This can be compared with an unadjusted synthetic season snowpack water equivalent of 17 in. (432 mm). By contrast, much farther south at Tree Point Light Station, similar computations give $98 \times 0.5 \times .24$ or 12 in. (305 mm) and are compared to a synthetic season snowpack of 6.5 in. (165 mm). Thus, for low-elevation stations with close to 100 in. (2540 mm) of MAP but widely separated geographically in our study area, the relation of computed snowpack water equivalent to the synthetic-season snowpack is quite similar. We think this lends support to the regional adjustment factors of figure 41.
2. Considering the fact that the procedure for computing snowpack water equivalent (sec. 4.7.3) is set up so as not to generally overmaximize snowpack water equivalent at the higher elevations, the results near and upwind of glaciers agree quite well with the areas of glaciers or of no glaciers.
3. For a far-southerly location, Jumbo Mine, at 1,500-ft (457 m) elevation, a short record has indicated a mean snowfall of 448 in. (11379 mm) and an extreme 579 in. (14707 mm) in a year. If we assume that 10 in. (254 mm) of snow equals 1 in. (25.4 mm) of liquid equivalent, the extreme case would have a water equivalent of 58 in. (1473 mm), if it all accumulated. Computations with generalized MAP give about 34 in. (863 mm) which increases to about 39 in. (991 mm) using a MAP value of 196 in. (4978 mm) based on the short-record at Jumbo Mine. In such a comparison, we need to keep in mind our computation procedure uses a basin's MAP (when less than 150 in. (3810 mm) throughout the elevation range which maximizes snowpack water equivalent at the lower elevation while diminishing somewhat the extremes at higher elevations.
4. Resulting snowpack water equivalent values at the locations where snow course data were available compared quite favorably. This also applied (i.e., favorable comparisons) where estimated snowmelt values were made from basin runoff data.

4.8 Example of Use of Snowmelt Criteria

We shall go through an example using the 18-mi² (47-km²) Takatz Creek basin. Specific elevations will be used covering the span of elevations in the basin. For temperatures and dew points, sample elevations only will be used. Ordinarily, for snowpack, due in part to the method used to maximize low-elevation snowpack, the use of a single mean elevation would produce similar

results as the use of the mean of unweighted separate elevation computations. However, the user may wish to weight the elevation (or elevation bands) by means of an area-elevation curve (step k. in sec. 4.7.4). Also for trial computations at various time placements of the PMP, the low-elevation snowpack for late placements may all melt prior to the selected critical hydrologic period for the basin. In our example, we shall use a May 15 PMP placement. The basic procedure does not change for computations for other time placements of the PMP. The computation of snowpack follows the procedural concepts set forth in section 4.7.3, and summarized as specific computational steps in section 4.7.4 while section 4.6 and schematic figures cover the steps for computing temperatures, dew points, and winds.

4.8.1 Snowpack Determination

The following steps are required to determine the snowpack for the Takatz Creek basin:

- a. The Takatz Creek basin is outlined in figure 4.
- b. From a detailed topographic chart covering the Takatz Creek basin, we determine that elevations from sea level to 5,000 ft (1,524 m). (For later computations of actual snowmelt criteria, the user should determine a satisfactory depiction of orography in the basin).
- c. Overlay the basin on MAP chart (fig. 6) and determine the average MAP for the basin. The average magnitude of the MAP will determine its use in the following fashion:
 1. If the basin average MAP is less than 150 in. (3810 mm), the average MAP is used without elevation adjustment throughout the basin.
 2. If the determined basin average MAP is equal to or greater than 150 in. (3810 mm), two-thirds of the basin average MAP is used at lowest basin elevation and four-thirds of the basin average MAP is used at highest basin elevation. Intermediate elevation values of MAP are then determined by assuming a linear variation of MAP with elevation.

We determine a MAP of 225 in. (5715 mm) for the basin from figure 6. Since this is greater than 150 in. (3810 mm), we assign (see step 2 above) a MAP value of 150 in. (3810 mm) to sea level and 300 in. (7620 mm) to 5,000 ft (1,524 m). With linear variation between sea level and 5,000 ft (1,524 m) this gives 15 in. (381 mm) increase per 500 ft (152 m).

- d. Using May 15 with figure 39 we read the following percents: SFC - 24; 500 ft - 29; 1,000 ft - 34; 1,500 ft - 39; 2,000 ft - 44; 2,500 ft - 49; 3,000 ft - 54; 3,500 ft - 58; 4,000 ft - 61; 4,500 ft - 64; and 5,000 ft - 67. (Note: Beyond 3,000 ft for a PMP date of May 15th, the percents come from extension of the intersection with the sloping elevation lines in the figure as the date is too early in the accumulation season at these higher elevations for the maximum snowpack to have yet been reached.)
- e. The MAP at the 500-ft incremental elevations from step c. are now each multiplied by the respective elevation percents from step d. The MAP, ratios of snowpack water equivalent to MAP, and unadjusted snowpack water equivalent are shown in columns (2), (3), and (4) of table 22, respectively.

Table 22.--Preliminary snowpack computations for 500-ft (152 m) elevation increments for Takatz Creek basin

(1)	(2)	(3)	(4)	(5)
Height (ft)				Regionally adjusted snowpack
sea level	MAP (in.)	Ratio	Snowpack (in.)	(in.)
sea level	150	.24	36.0	32
500	165	.29	47.9	43
1,000	180	.34	61.2	55
1,500	195	.39	76.0	68
2,000	210	.44	92.4	83
2,500	225	.49	110.2	99
3,000	240	.54	129.6	117
3,500	255	.58	147.9	133
4,000	270	.61	164.7	148
4,500	285	.64	182.4	164
5,000	300	.67	201.0	181

- f. From figure 41 the ratio for the Takatz Creek basin is 0.9. The unadjusted snowpacks computed in step e. are now multiplied by 0.9. The results are shown in column (5) of table 22.
- g. Based upon required snowmelt up to May 15 from figure 40 the regionally adjusted values in table 22 up to 2,500 ft (last incremental elevation needing a prior melt adjustment from figure 40) need to have appropriate melt subtracted. The melt-adjusted values are shown in table 23.

Table 23.—Final snowpack values for 500-ft (152 m) elevation increments Takatz Creek basin

Elevation (ft)	Regionally adjusted snowpack (in.)	Melt	Melt adjusted snowpack (in.)
Sea level	32	10	22
500	43	9	34
1,000	55	7	48
1,500	68	6	62
2,000	83	4	79
2,500	99	2	97
3,000	Same as regionally adjusted values in table 22		

4.8.2 Temperature Criteria Prior to Probable Maximum Precipitation

Due to the frequency with which temperatures and dew points will be given in subsequent sections, particularly where long sequences are involved, the values will be given in degrees Fahrenheit only. The user may obtain celsius equivalents with the formula: $C = \frac{5}{9} (F-32)$.

- a. Since we chose May 15 for our example, we read from figure 31, 46°F.
- b. For the high-temperature case (using departures shown in figure 33), a sequence of temperatures beginning 6 days prior to the first day of the 3-day PMP event will be 56°, 58.5°, 53.5°, 52°, 52° and 52°F. [Note: If the mean temperature for any day were to exceed 62°F, 62°F temperature would be used for that day (sec. 4.2.3, fig. 33)]
- c. For the high-dew-point case, the temperatures for beginning 6 days prior to first day of the 3-day PMP event are: 51°, 51°, 49°, 48°, 48° and 48°F.
- d. In applying elevation adjustments (fig. 33), we shall work with a single elevation, 1,000 ft, since corrections for other elevations would simply be at the same rate. Hence, for 1,000 ft, subtracting 4°F from the readings in step b. gives, 52°, 54.5°, 49.5°, 48°, 48° and 48°F for the high-temperature case. Likewise, in subtracting 3°F from the high-dew-point sequence, we get for 1,000 ft, 48°, 48°, 46°, 45°, 45°, and 45°F.

4.8.3 Dew-Point Criteria Prior to Probable Maximum Precipitation

- a. Dew points for the high-temperature case come from the adjustments on figure 35. For a 6-day sequence

prior to the first day of the 3-day PMP event, the adjustments are -18° , -18° , -18° , -13° , -13° and -13° F. Application of these adjustments to the high-temperature case values of section 4.8.2.d gives the dew-point sequence: 34° , 36.5° , 31.5° , 35° , and 35° F.

- b. Dew points for the high-dew-point case also come from adjustments on figure 35 and are -8° , -8° , -6° , -4° , -4° and -4° F. Application of these adjustments to the high-dew-point case values of section 4.8.2.d gives the dew-point sequence 40° , 40° , 40° , 41° , 41° , and 41° F.

4.8.4 Temperature and Dew-Point Criteria During the Probable Maximum Precipitation

As pointed out in section 4.6.3, the temperatures during the 3-day PMP event are determined by the dew points.

- a. Variation of mean dew point over a few days is slight. We shall read the maximum 1-day dew point applicable for May 15 from the mid-May map of figure 34. We read 50.5° F. This is both dew point and temperature.
- b. Since our PMP date is May 15, we do not need to develop a smooth curve through values for successive months and interpolate for the desired date.
- c. Subtracting 2° F (step c.3, fig. 35, and sec. 4.6.3) from 50.5° F gives 48.5° F for the second highest rainfall day of the PMP. This is both dew point and temperature.
- d. Subtracting 4° F (step d.3, fig. 35, and sec. 4.6.3) from 50.5° F gives 46.5° F for the third highest rainfall day of the PMP. This is both dew point and temperature.
- e. The three days of dew points and temperatures adjusted for a 1,000-ft elevation are 47.5 , 45.5 , and 43.5° F (i.e., $-3^{\circ}/1,000$ ft) applied to temperatures in a., c., and d. of this section.

4.8.5 Half-Day Values of Temperatures and Dew Points

- a. During the 3-day PMP event, half-day (maximum and minimum dew points) values come from applying $\pm 2^{\circ}$ F and are, therefore, 48.5° and 52.5° F (maximum day of PMP) 46.5° and 50.5° F, and 44.5° and 48.5° F (lowest day of PMP). Likewise, for the 3 days of maximum and minimum temperatures during PMP, we get by applying $\pm 2^{\circ}$ F, 48.5° and 52.5° F, 46.5° and 50.5° F, and 44.5°

and 48.5°F. The 1,000-ft values are obtained by subtracting 3°F from all of the above values.

- b. For half-day dew points for the high-temperature case prior to the 3-day PMP event, we apply +3°F to the values of step a, section 4.8.3. Thus, we get 35° and 41°F, 37.5° and 43.5°F, 32.5° and 38.5°F, 36° and 42°F, 36° and 42°F, and 36° and 42°F. The 1,000-ft values are obtained by subtracting 4°F from all the above values.
- c. For half-day dew points for the high-dew-point case prior to the 3-day PMP event, we apply +2°F to the values of step b. of section 4.8.3. Thus, we get 41° and 45°F, 41° and 45°F, and 41° and 45°F, 42° and 46°F, 42° and 46°F, and 42° and 46°F. The 1,000-ft values are obtained by subtracting 3°F from all of the above values.
- d. To obtain half-day temperatures for the high-temperature case prior to the 3-day PMP event, we apply +9°F to the values of step b., section 4.8.2. Thus, we get 47° and 65°F, 49.5° and 67.5°F, 44.5° and 62.5°F, 43° and 61°F, 43° and 61°F, and 43° and 61°F. The 1,000-ft values are obtained by subtracting 4°F from all of the above values.
- e. To obtain half-day temperatures for the high-dew-point case prior to the 3-day PMP event, we apply +6°F to the values of step c., section 4.8.2. Thus, we get 45° and 57°F, 45° and 57°F, 43° and 55°F, 42° and 54°F, 42° and 54°F, and 42° and 54°F. The 1,000-ft values are obtained by subtracting 3°F from all above values.

4.8.6 Wind Criteria

4.8.6.1 Winds During Probable Maximum Precipitation. Except for determination of barrier adjustments explained in section 4.4.1.2, the wind criteria both for prior to and during PMP may be determined from following the wind schematic of figure 36. We shall develop the wind criteria for the Takatz Creek by a stepwise procedure.

- a. The no-barrier all-season 3 days of PMP wind are 36, 28, and 25 mph (16.1, 12.5 and 11.2 m/s), respectively. For May 15, our placement date, these values reduce to 33, 26, and 23 mph (14.8, 11.6, and 10.3 m/s), (i.e., 92 percent of the April values).
- b. Using the generalized barrier chart (fig. 5), lines are drawn from the center of the basin to the coast toward the following directions: 256°, 229°, 202°, 175°, and 148°. The maximum barriers intersected

along each of these lines to the coast are read from figure 5. These are estimated to the nearest 500 ft (152 m), 5,000, 4,000, 3,500, 3,000 and 3,000 ft (1,524, 1,220, 1,067, 914 and 914 m). The mean of these elevations is 3,700 ft (1,128 m). Therefore, we reduce the basic winds for the 3 days of the PMP event by 18.5 percent (i.e., 3.7×5). This gives 27, 21, and 19 mph (12.2, 9.4, 8.5 m/s) for barrier-adjusted values.

- c. Since the elevation adjustment of winds is nonlinear (unlike the adjustments for temperature and/or dew point), we shall compute winds for two separate elevations, 1,000 and 5,000 ft (305 and 1,524 m) to adequately illustrate the procedure. For 1,000 ft (305 m), the winds for the 3-day PMP event are (using 107 percent from figure 36) 29, 22 and 20 mph (13.0, 9.8, and 8.9 m/s). The 5,000-ft winds are (using 225 percent from figure 36) 61, 47, and 43 mph (27.3, 21.0, and 19.2 m/s)

4.8.6.2 Winds Prior to Probable Maximum Precipitation

- a. For the high-temperature case, the basic May 15 maximum 1-day wind for the PMP event of 33 mph (14.8 m/s) (step a.1, section 4.8.6.1) is multiplied by the following percents (fig. 36) for a wind sequence beginning 6 days prior to the 3-day PMP event: 29, 29, 29, 19, 55 and 42. This gives for sea level a sequence of winds of 10, 10, 10, 6, 18 and 14 mph (4.5, 4.5, 4.5, 2.7, 8.0, and 6.3 m/s).
- b. The high-temperature case 1,000-ft (305-m) (102 percent, fig. 36) and 5,000-ft (1,524-m) (134 percent, fig. 41) winds are: 10, 10, 10, 6, 18 and 14 mph (4.5, 4.5, 4.5, 2.7, 8.0, and 6.3 m/s) and 13, 13, 13, 8, 24, and 19 mph (5.8, 5.8, 5.8, 3.6, 10.7, and 8.5 m/s), respectively.
- c. For the high-dew-point case, the basic May 15 maximum 1-day wind for the 3-day PMP event of 33 mph (14.8 m/s) is multiplied by the following percents (fig. 36) for a wind sequence beginning 6 days prior to the 3-day PMP event: 29, 29, 29, 32, 65, and 55. This gives a sea-level sequence of winds of 10, 10, 10, 11, 21, and 18 mph (4.5, 4.5, 4.5, 4.9, 9.4, and 8.0 m/s)
- d. The high-dew-point case 1,000-ft (305-m) (107 percent, fig. 36) and 5,000-ft (1,524-m) (225 percent, fig. 36) winds are: 11, 11, 11, 12, 22, and 19 mph; (4.9, 4.9, 4.9, 5.4, 9.8, and 8.5 m/s) and 22, 22, 22, 25, 47, and 40 mph (9.8, 9.8, 9.8, 11.2, 21.0, and 17.9 m/s), respectively.

ACKNOWLEDGEMENTS

The authors express their appreciation to John T. Riedel, former Chief of the Hydrometeorological Branch, and E. Marshall Hansen, present Chief of the Branch, and to their colleagues in the Water Management Information Division for their many helpful comments during the course of this study and for their editorial review of the final manuscript.

Appreciation is also due to the technician staff consisting of Keith Bell, Marion Choate, Roxanne Johnson, and Teresa Nero for performing much of the background work, and to Clara Brown and Helen V. Rodgers for typing and editorial assistance.

REFERENCES

- Anderson, E., National Weather Service, National Oceanic and Atmospheric Administration, U.S. Department of Commerce, Silver Spring, MD, 1977: personal communication.
- Environment Canada, 1973: Canadian Normals, Precipitation, 1941-1970. Vol. 2, Downsview, Ontario, Canada, 330 pp.
- Environmental Data Service, 1973: Monthly Normals of Temperature Precipitation and Heating and Cooling Days, 1941-1970, Climatology of the United States, No. 81 (Alaska), National Oceanic and Atmospheric Administration, U.S. Department of Commerce, Asheville, NC, 7 pp.
- Brower, William A., Jr., Diaz, Henry F., Precktel, Anton S., Searby, Harold W., and Wise, James L, 1970: Climatic Atlas of the Outer Continental Shelf Waters and Coastal Regions of Alaska: Volume 1, Gulf of Alaska. Environmental Information and Data Center, University of Alaska, Anchorage, Alaska, and National Climatic Center, Environmental Data Service, National Oceanic and Atmospheric Administration, Asheville, NC, 439 pp.
- Freeman, T.B., 1970: Summary of Snow Survey Measurements for Alaska, Soil Conservation Service, U.S. Department of Agriculture, Anchorage, Alaska, 101 pp.
- Hansen, E. Marshall, and Schwarz, Francis K., 1977: Probable Maximum Precipitation Estimates, Colorado River and Great Basin Drainage. Hydrometeorological Report No. 49, National Oceanic and Atmospheric Administration, U.S. Department of Commerce, Silver Spring, MD, 161 pp.
- Hydrometeorological Branch (Office of Hydrology, Weather Bureau, U.S. Department of Commerce, Washington, D.C.) 1961: Probable Maximum Precipitation for Bradley Lake Basin. Unpublished manuscript, 23 pp.
- Hydrometeorological Branch (Office of Hydrology, Weather Bureau, U.S. Department of Commerce, Washington, D.C.) 1962: Estimates of Probable Maximum Precipitation and Snowmelt Criteria for Chena River Basin, Alaska. Unpublished manuscript, 42 pp.
- Hydrometeorological Branch (U.S. Weather Bureau, U.S. Department of Commerce, Washington, DC), 1965: Preliminary Estimates of Probable Maximum Precipitation and Snowmelt Criteria for the 302-Square Mile Long Lake Portion of the Snettisham Project. Unpublished manuscript, 15 pp.
- Hydrometeorological Branch (Weather Bureau, Environmental Science Services Administration, U.S. Department of Commerce, Washington, DC), 1967: Estimates of Probable Maximum Precipitation and Snowmelt Criteria for Takatz Creek, Baranof Island, Alaska. Unpublished manuscript, 18 pp.
- Hydrometeorological Branch (National Weather Service, National Oceanic and Atmospheric Administration, U.S. Department of Commerce, Silver Spring, MD), 1974: Probable Maximum Precipitation for Four Watersheds Near Ketchikan, Alaska. Unpublished manuscript, 7 pp.

- Hydrometeorological Branch (National Weather Service, National Oceanic and Atmospheric Administration, U.S. Department of Commerce, Silver Spring, MD), 1975: Tentative Estimates of Probable Maximum Precipitation (PMP) and Snowmelt Criteria for Four Susitna River Drainage. Unpublished manuscript, 15 pp.
- Kilday, Gordon, D., 1974: Mean Monthly and Annual Precipitation Alaska, NOAA Technical Memorandum NWS AR-10, National Weather Service, National Oceanic and Atmospheric Administration, U.S. Department of Commerce, Anchorage, Alaska, 13 pp.
- Klein, W. H., 1957: Principal Tracks and Mean Frequencies of Cyclones and Anticyclones in the Northern Hemisphere. Research Paper No. 40, Weather Bureau, U.S. Department of Commerce, Washington, DC, 60 pp.
- Miller, J. F., 1963: Probable Maximum Precipitation and Rainfall-Frequency Data for Alaska. Technical Paper No. 47, Weather Bureau, U.S. Department of Commerce, Washington, DC, 69 pp.
- Miller, J. F. 1965: Two- to Ten-Day Precipitation for Return Periods of 2 to 100 Years in Alaska. Technical Paper No. 52, U.S. Weather Bureau, U.S. Department of Commerce, Washington, DC, 30 pp.
- Ratner, Benjamin, 1957: Upper-air Climatology of the United States. Part I. Averages of Isobaric Surfaces-Height, Temperature, Humidity and Density. Technical Paper No. 32, U.S. Weather Bureau, U.S. Department of Commerce, Washington, DC, 199 pp.
- Sanford, Henry R., National Weather Service, National Oceanic and Atmospheric Administration, U.S. Department of Commerce, Anchorage, Alaska, 1977: Personal communication.
- Schreiner, Louis C., and Riedel, John T., 1978: Probable Maximum Precipitation Estimates, United States East of the 105th Meridian. Hydrometeorological Report No. 51, National Weather Service, National Oceanic and Atmospheric Administration, U.S. Department of Commerce, Washington, D. C., 87 pp.
- Thompson, H. J., 1947: Climate of Southeast Alaska, in Water Powers Southeast Alaska, Federal Power Commission and Forest Service, U.S. Department of Agriculture, Washington, DC, pp. 13-27.
- U.S. Weather Bureau 1961: Interim Report, Probable Maximum Precipitation in California, Hydrometeorological Report No. 36, U.S. Department of Commerce, Washington, DC, 202 pp.
- U.S. Weather Bureau, 1965: Mean Annual Precipitation, 1930-1957, State of Washington. Soil Conservation Service, U.S. Department of Agriculture in cooperation with Weather Bureau, U.S. Department of Commerce, Portland, OR, 1 sheet.
- U.S. Weather Bureau, 1966a: Meteorological Conditions for Probable Maximum Flood on the Yukon River Above Rampart, Alaska. Hydrometeorological Report No. 42, Environmental Science Services Administration, U.S. Department of Commerce, Washington, D.C., 97 pp.

U.S. Weather Bureau, 1966 b: Probable Maximum Precipitation, Northwest States, Hydrometeorological Report No. 43, U.S. Department of Commerce, Washington, D. C., 226 pp.

Walker, Edward R., 1961: A Synoptic Climatology for Parts of the Western Cordillera. Publication in Meteorology No. 35, McGill University, Montreal, Canada, 218 pp.

World Meteorological Organization, 1969: Estimation of Maximum Floods. WMO No. 233, TP 126, Technical Note No. 98, Geneva, Switzerland, 288 pp.

APPENDIX A

Summary of the Availability of Streamflow Records for Southeast Alaska

Streamflow data from various sources were collected, reviewed, summarized, and compared. Water Supply Paper No. 1372 (U. S. Geological Survey, 1957) summarized streamflow data through September 1950 on an hourly and yearly basis. A bar chart on page 15 of this report summarized the available data. Some miscellaneous early records that this paper did not include may be found in a Federal River Commission Report (Federal Power Commission and U.S. Department of Agriculture, 1947). These are identified in table 2. Except for these early records, stream gaging numbers are assigned by the U.S. Geological Survey.

Water Supply Paper No. 1372 summarizes by daily and monthly discharges the records for the years 1946-50. This summation in report 1372 includes examination and correction of computational errors previously made. In some cases where revision was considered necessary but not possible to accomplish, the record was eliminated. On the other hand, wherever possible, estimates of streamflow were made to "fill short gaps to complete the continuity of record."

The period 1950 to September 1960 was covered in Water Supply Paper No. 1740, while Water Supply Paper No. 1936 covers the 1960 to 1965 period. These water supply papers give daily discharges. Mean discharges are given for only those gaging stations with 5 years or more of record. Since 1965 streamflow data are obtained from annual copies of Water Resources Data for Alaska. (U.S. Geological Survey, various years)*.

*U.S. Geological Survey, 1966-1974: Water Resources Data for Alaska, Part I Surface Weather Records Data for Southeast Alaska, Department of Interior.